

Allon[®]

User Manual



Conformity according to the Council Directive 93/42/EEC



Manufactured for:

 Belmont Medical Technologies
780 Boston Road
Billerica, MA 01821 USA
Technical Service
885-397-4547 (USA)
+1-978-663-0212 (WORLDWIDE)
www.BelmontMedTech.com

European Representative:

EC REP
Emergo Europe
Westervoortsedijk 60
6827 at Arnhem
The Netherlands

Switzerland Authorized Representative:

CH REP
Medenvoy Switzerland
Gotthardstrasse 28
6302 ZUG
Switzerland

Copyright 2023 by Belmont Medical Technologies. All RIGHTS RESERVED
Registered trademarks are the intellectual property of their respective holders.

Use Of Manual

The purpose of this manual is to help qualified personnel understand and operate the system. It is important that you read this manual and familiarize yourself thoroughly with its contents before you attempt to operate the system. If you do not understand any part of this manual, or if anything is unclear or ambiguous in any way, please contact your Belmont Medical Technologies representative for further clarification.

The Allon 2001® system described in this manual has been designed to meet international safety and performance standards. Only qualified personnel may operate the system, and these operators must first have a full understanding of the proper operation of the system.

The information provided in this manual is not intended to replace regular medical training procedures.

This manual should always accompany the system. All qualified personnel operating the system should know the location of the manual. For additional copies of this manual, please contact your Belmont Medical Technologies representative.

Training

Belmont Medical Technologies or its authorized distributor will provide training for the system user according to the intended use of the device or system.

It is the responsibility of the end user to ensure that only users trained to use the equipment efficiently and safely, operate the equipment.

Operator Profile

Connections and device settings should, typically, be performed by a clinician expert in thermoregulation.

Important Notice

No part of this manual may be reproduced or copied in any form by any graphic, electronic, or mechanical means - including photocopying, scanning, typing or information retrieval systems - without advanced written permission from Belmont Medical Technologies.

Patent Nos. US 6,500,200 B1, US 5,508,831 B1, US 6,685,731 B1

NOTE: All instructions regarding the reusable temperature probes are NOT applicable for use in the USA market and other select markets.

Disclaimer

Belmont Medical Technologies is not responsible for any consequential or incidental damages or expenses of any kind, impairment of or damage to other goods caused by the following:

- a. Installed, operated, maintained contrary to Belmont Medical Technologies instructions, notes, or warnings under this manual.
- b. Ignoring any of the warnings, precautions and safety measures indicated in this manual.
- c. Replacement, repair or alteration not performed by Belmont Medical Technologies or authorized personnel.
- d. The use of accessories and other parts or equipment made by other manufacturers, whether or not warranted by such manufacturers, which have been attached or connected to the System after installation, unless such accessories and other parts have been supplied and attached or installed by Belmont Medical Technologies.
- e. Using the system in a contrary manner than indicated in this manual or using the system for any purpose other than indicated in the manual.

Table Of Contents

Use Of Manual	3
Chapter 1: Safety Precautions	9
<i>Definitions</i>	9
<i>Intended Use</i>	9
<i>Warnings</i>	9
<i>Precautions</i>	10
<i>EMC Safety</i>	11
<i>Labels</i>	12
Chapter 2 System Description	15
<i>General Description</i>	15
<i>Allon® System</i>	15
<i>Allon® Device</i>	16
<i>External Features</i>	17
<i>Front View</i>	17
<i>Side View</i>	18
<i>ThermoWrap®</i>	20
<i>Selected Wrap Design</i>	21
<i>Accessories</i>	24
<i>System Specifications</i>	28
Chapter 3: Installation	32
<i>Pre-installation Requirements</i>	32
<i>Space and Environmental Requirements</i>	32
<i>Electrical Requirements</i>	32
<i>Unpacking and Inspection</i>	32
<i>Moving the Unit</i>	35
Chapter 4: Operating Instructions	36
<i>Control Panel</i>	37
<i>Getting Started</i>	38
<i>Preparing the System for Operation</i>	38
<i>Turning on the System</i>	39
<i>Self-Test Messages</i>	40
<i>Pre-heating Water</i>	40
<i>Connect ThermoWrap® to Allon®</i>	41
<i>Preparing the Patient</i>	41
<i>Inserting and Attaching Temperature Probes</i>	42
<i>Main Screen</i>	43
<i>Menu Options</i>	44
<i>Standby</i>	45
<i>Normothermia Mode</i>	47
<i>Manual Mode</i>	48
<i>Temperature Graph</i>	49
<i>Settings</i>	51
<i>Section 1:</i>	52

Section 2: Adjustable Alarm Limits	54
Section 3: Set Date and Time	55
Services	56
Empty	56
System Check	58
Thermal Disinfection Process	59
Turning off the System	60
Chapter 5: Ordering Information.....	62
Equipment and Accessories	62
Chapter 6: Maintenance.....	65
Introduction	65
Service Information	65
Routine Maintenance.....	65
Cleaning and Disinfection.....	66
Routine Maintenance.....	67
Before Each Use	68
Before Storage	68
Thermal Disinfection.....	70
Cleaning, Disinfecting and Sterilization of the Reusable Temperature Probes.....	70
Filter Replacement	71
System Check Service	71
Chapter 7: Troubleshooting	74
General	74
Troubleshooting Guide	74
Chapter 8: Messages And Alarms	82
Technical Messages and Alarms.....	82
Clinical Messages and Alarms.....	84
Safety Messages and Alarms.....	85
Informative Messages	86
Loss of Power Indicator	87
Alarm Delay.....	87
Chapter 9: Optional Clinilogger™.....	88
Installation And Operating Instructions	88
Overview and Installation	88
Introduction	88
Using the CliniLogger™ Application	88
The CliniLogger™ Software.....	88
Installing the Software	88
Using the CliniLogger™ Viewer Application.....	92
Downloading Data	92
CliniLogger™ Viewing Panel	95
Graphic Display Area.....	96
Function Selection Area	97
Temperature Graph Control Buttons:.....	97
Measurement Table (Sheet 1)	102

Ending a Viewing Session	103
Appendix A: Customer Service.....	104
Appendix B: EMI / EMC Information	105
Appendix C: Waste Electrical & Electronic Equipment (WEEE)	107

List of Tables

Table 1: Label Symbols	13
Table 2: ThermoWrap® Sizes	23
Table 3: Disposable Sensors	26
Table 4: Reusable Sensor and Data Provider Input Specifications.....	26
Table 5: ThermoWrap® Sizes	62
Table 6: Allon® Accessory Kits	63
Table 7: Accessories Individual Replacement	64
Table 8: Inspection and Maintenance Schedule	66
Table 9: Allon® System (No Message) Troubleshooting Guide	75
Table 10: Water Tank Overfilled- Draining the Water Tank	76
Table 11: Allon® System Messages Troubleshooting Guide.....	77
Table 12: Technical Messages and Alarms.....	82
Table 13: Clinical Messages and Alarms	84
Table 14: Zoom Tool Buttons	98
Table 15: Mode Codes.....	100
Table 16 Guidance and Manufacturer's Declaration - Emissions	105
Table 17 Guidance and Manufacturer's Declaration - Immunity	106

List of Figures

Figure 1: Label Placement for the Allon Device.....	12
Figure 2: Front View.....	17
Figure 3: Side View	18
Figure 4: Rear View	19
Figure 5: Cardiac ThermoWrap®	21
Figure 6: Universal ThermoWrap®	21
Figure 7: Universal (Pediatric) ThermoWrap®	21
Figure 8: Infant ThermoWrap®	21
Figure 9: Infant ThermoWrap®	22
Figure 10: Measurements	22
Figure 11: Disposable Temperature Probe Connections.....	25
Figure 12: Temperature Splitter	28
Figure 13: Handle Assembly	34
Figure 14: Control Panel	38
Figure 15: Initial Self-Test Screen	39
Figure 16: Preheating Water	40
Figure 17: Main Screen- Default Normothermia	43
Figure 18: Menu Options.....	44
Figure 19: Stand-by Mode.....	45
Figure 20: Mode Select.....	46

Figure 21: Select Set Point Temperature	47
Figure 22: "Out of Normothermia" Message	48
Figure 23: Manual Mode Screen	49
Figure 24: Select Water Out Temperature	49
Figure 25: Temp Graph Mode	50
Figure 26: Settings Screen.....	52
Figure 27: All Temp Sensors Alarm Off Indicator	53
Figure 28: Adjustable Alarm Limits.....	54
Figure 29: Set Date and Time	55
Figure 30: Services Screen.....	56
Figure 31: Empty Mode.....	57
Figure 32: Empty Mode.....	57
Figure 33: Tank is Empty	58
Figure 34: Thermal Disinfection Mode.....	60
Figure 35: Selecting System Check	72
Figure 36: System Check in Progress	73
Figure 37: ThermoWrap® Connecting Tubes and Special Male Connector	76
Figure 38: CliniLogger™ Initialization.....	89
Figure 39: CliniLogger™ Installation	89
Figure 40: CliniLogger™ Agreement.....	90
Figure 41: Start Installation	90
Figure 42: Installation Progress.....	91
Figure 43: Installation Complete.....	91
Figure 44: CliniLogger™ Application Window	92
Figure 45: CliniLogger™ Window.....	93
Figure 46: CliniLogger™ Window.....	94
Figure 47: "Complete" Message.....	94
Figure 48: CliniLogger™ Viewing Panel.....	95
Figure 49: Graphics Display Area	96
Figure 50: Function Selection Area	97
Figure 51: Example Modes and Errors Area	97
Figure 52: Zoom Toolbar.....	98
Figure 53: Example of "Modes and Error Area"	100
Figure 54: Selection of Graph Chart.....	103

Chapter 1: Safety Precautions

Definitions

WARNING!!! Indicates a condition that may endanger the patient or the system operator.

CAUTION! Indicates a condition that may damage the equipment.

NOTE: Indicates ways in which the system's operation can be made more efficient.

Intended Use

Allon® is intended to maintain pre-set body temperature as determined by the physician. It can also be utilized to maintain normal body temperature during surgical procedures. This system can be used for adult and pediatric patients.

Warnings

1. The physician must be notified if the patient's temperature does not respond properly, does not reach the prescribed temperature, or if there is any change in the prescribed temperature range. Failure to inform the physician may result in injury to the patient.
2. The patient should be under constant supervision of the medical staff.
3. The misuse of the temperature regulation equipment can be potentially harmful to the patient.
4. Do not plug wet probes into the sockets of the Allon® device.
5. The user should verify that no fluids are present at the skin/wrap interface during the procedure. Failure to do so can cause lesions on the patient's skin. Following the procedure, a pattern resembling the wrap may appear for a short period of time on the patient's skin.
6. Pressure sores may appear or develop when soft tissue is compressed between a bony prominence and external surface. The use of the Allon® system does not prevent this from happening.
7. In order to prevent pressure sores, hospital routine care should be taken during long thermoregulation procedures.

8. Do not lift or move the patient by means of the Wrap. This may cause tearing and water leakage from the Wrap.
9. Use only probes or adapters supplied by Belmont Medical Technologies.
10. The technical principles, clinical applications, and risks associated with circulatory support must be thoroughly understood before using this product.
11. Read the entire manual before attempting to activate the system.
12. Completion of the training program prior to using the Allon[®] system is mandatory.
13. The repair, calibration, and servicing of the Allon[®] system should be performed only by Belmont Medical Technologies or authorized agents trained by Belmont Medical Technologies.
14. Prevent any thermal isolation, such as a pillow or other items, between the ThermoWrap[®] and the patient's body.
15. Do not apply heating/cooling to lower extremities during aortic cross clamping. Thermal injury may occur if heating/cooling is applied to ischemic limbs.
16. Wraps should not be placed over transdermal patches.
17. Wrap should not come in contact with open wounds.
18. Do not touch the ribbon cable behind the display and the patient simultaneously.

Precautions

1. Follow the warning notes listed in the various sections of this manual.
2. Only trained personnel, familiar with all system operating procedures and certified only by Belmont Medical Technologies or authorized agents of Belmont Medical Technologies are allowed to use the Allon[®] system. All hospital personnel using the Allon[®] system must complete the Allon[®] training program.
3. If moisture or leaks are discovered in the connecting hose and/or Wrap, turn off the Allon[®] device, disconnect the power cable from its power source, and correct the problem before proceeding.
4. The desired set-point temperature should be fixed only as prescribed by and under the order of a physician.
5. The default setting is intended to maintain Normothermia. The system provides the physician with the option of selecting a body temperature in the range of 30°C to 40°C (86°F-104°F).

6. If the device sounds an alarm and/or presents a display other than the standard Belmont Medical Technologies display, the operator should proceed according to the display message and/or the troubleshooting instructions (see Chapter 7: Troubleshooting).
7. Avoid folds in the Wrap—these may obstruct water flow.
8. Do not block the Allon[®] device ventilation grilles. Air must be able to flow freely in and out to keep the device cool.
9. Use sterile or 0.22 μ filtered water. Do not use de-ionized water or water created through reverse osmosis because it may promote corrosion of the metal components of the system.
10. When X-ray imaging is performed on a patient wearing a Wrap, shadows from the Wrap may appear on the X-ray film.
11. Avoid inserting any sharp object between the patient and the Wrap.
12. Storage of Wraps is recommended at temperatures 10°C to 27°C and 10%-90% humidity.

EMC Safety

For safe use of the Allon[®], it is required to keep the Allon[®] at a safe distance from devices emitting radio frequency energy.

Refer to Appendix B for recommended separation distances between the Allon[®] and RF source.

WARNING!!! To avoid the risk of electric shock, this equipment must only be connected to a supply mains with protective earth.

CAUTION! Power interrupts affect the functionality of the system, depending on the mode of operation:

- Interruptions longer than 10 minutes return the machine to the Start-up Screen. An alarm will sound when the power is returned to indicate that the machine has returned to the Startup screen.
- Interruptions shorter than 10 minutes return the machine to the mode that was operating before the interruption, but a warning will appear.

NOTE: Make sure to read the messages to ensure correct reactivation of the machine.

NOTE: Do not position equipment in a location that will make it difficult to operate equipment.

Improper Use

Improper use of the Allon[®] system can lead to skin lesions, electrical hazards, and severe changes in body temperature.

WARNING!!! The technical principles, clinical applications, and risks associated with circulatory support must be thoroughly understood before using this product. Read the entire manual before attempting to activate the system. Completion of the training program prior to using the Allon[®] system is mandatory.

CAUTION! U.S. Federal law restricts this device to sale by or on the order of a physician.

Labels











Allon[®] Device Labels











Figure 1: Label Placement for the Allon Device

Label Symbols

Table 1: Label Symbols

Description	Symbol
CE mark of conformity indicates that the product has received the European approval for MDD 93/42/EEC.	
AC Voltage	
Fuse	
The serial number for this product	
Catalogue part number	
European Authorized Representative	
Switzerland Authorized Representative	
Caution – refer to user manual	
Type BF equipment	
Recycle for WEEE	
Date of manufacture	

Description	Symbol
Name of manufacturer	
Country of manufacturer	
Do not push	
Refer to instruction manual / booklet	
Restricts the sale and use of this instrument to qualified medical personnel only.	R_xOnly
Unique Device Identifier	UDI
Instructions for Use	
Does not contain natural rubber latex	
Medical Device	MD
Do Not Reuse	
Not safe in MRI	
Use sterile or 0.22 µ filtered water only. Tap water usage is not permitted.	

Chapter 2 System Description

General Description

The Allon[®] system maintains desired patient body temperature before, during and after surgery. The desired patient temperature is set by the clinician and covers the normothermia to hypothermia range. Most surgical procedures require normothermia in order to compensate for body heat losses resulting from general anesthesia, reduced metabolic rate and exposure of body organs and skin to the cold operating theatre environment.

The system is composed of two elements, the Allon[®] device and the ThermoWrap[®] disposable wrap. The Allon[®] device performs the functions of heat pump, water circulating pump, and control unit.

The control unit constantly monitors the patient's core temperature every 133 milliseconds through specific sensors and, using its on-board body temperature control algorithm, adjusts water temperature to the desired set point. The heat pump brings the water to the required temperature and the pump circulates it to the wrap. The touch screen allows the user to change settings in an easy and convenient way.

The ThermoWrap[®] wrap is a flexible heat exchanger through which the water circulates. It is designed to be in close contact with a large area of the body, thus effecting heat transfer with the body. ThermoWrap are single use, disposable and come in a variety of shapes and sizes to address various types of surgical procedures and patient.

The device can prewarm the wrap from 23°C to 37°C in less than 5 minutes.

Allon[®] System

The Allon[®] system consists of the following elements:

- Allon[®] device
- ThermoWrap[®]
- Accessories

Allon[®] Device

The Allon[®] device has a microprocessor that controls the water temperature flowing into the ThermoWrap[®] worn by the patient. The algorithm to correct the water temperature is based on the desired set point temperature and the actual measured patient temperature (Core and Surface).

Water pressure and flow in the wrap is regulated by timed pauses of the flow during clinical operation.

During the initial phase of regulation, the flow cycle is 12 minutes ON and 1 minute OFF.

In steady state (when the Core Temperature is within the Set Point range), the cycle is 12 minutes ON and 12 minutes OFF.

The Allon[®] is equipped with a handle for easy transport.

External Features

Front View

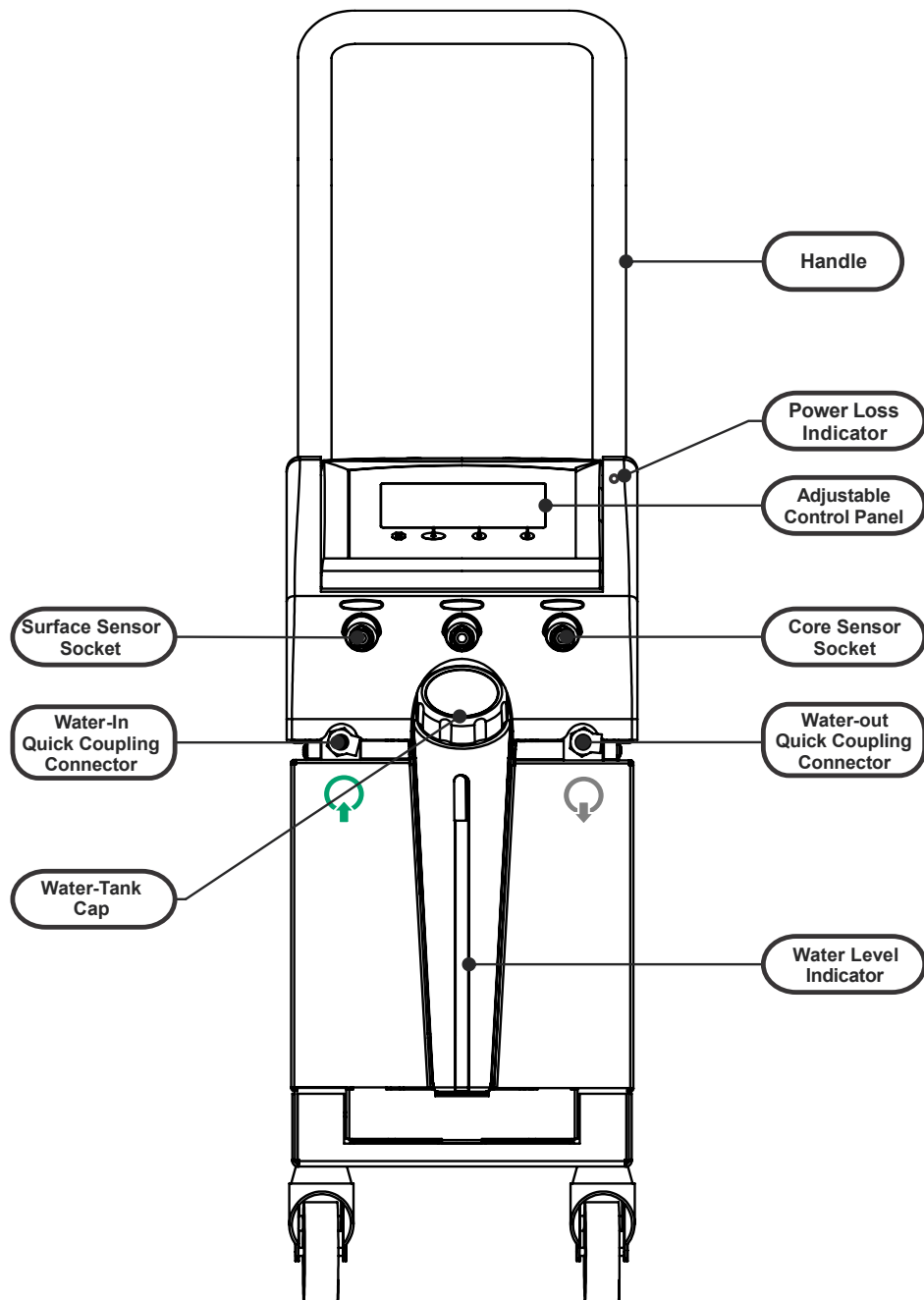

Figure 2: Front View

Side View

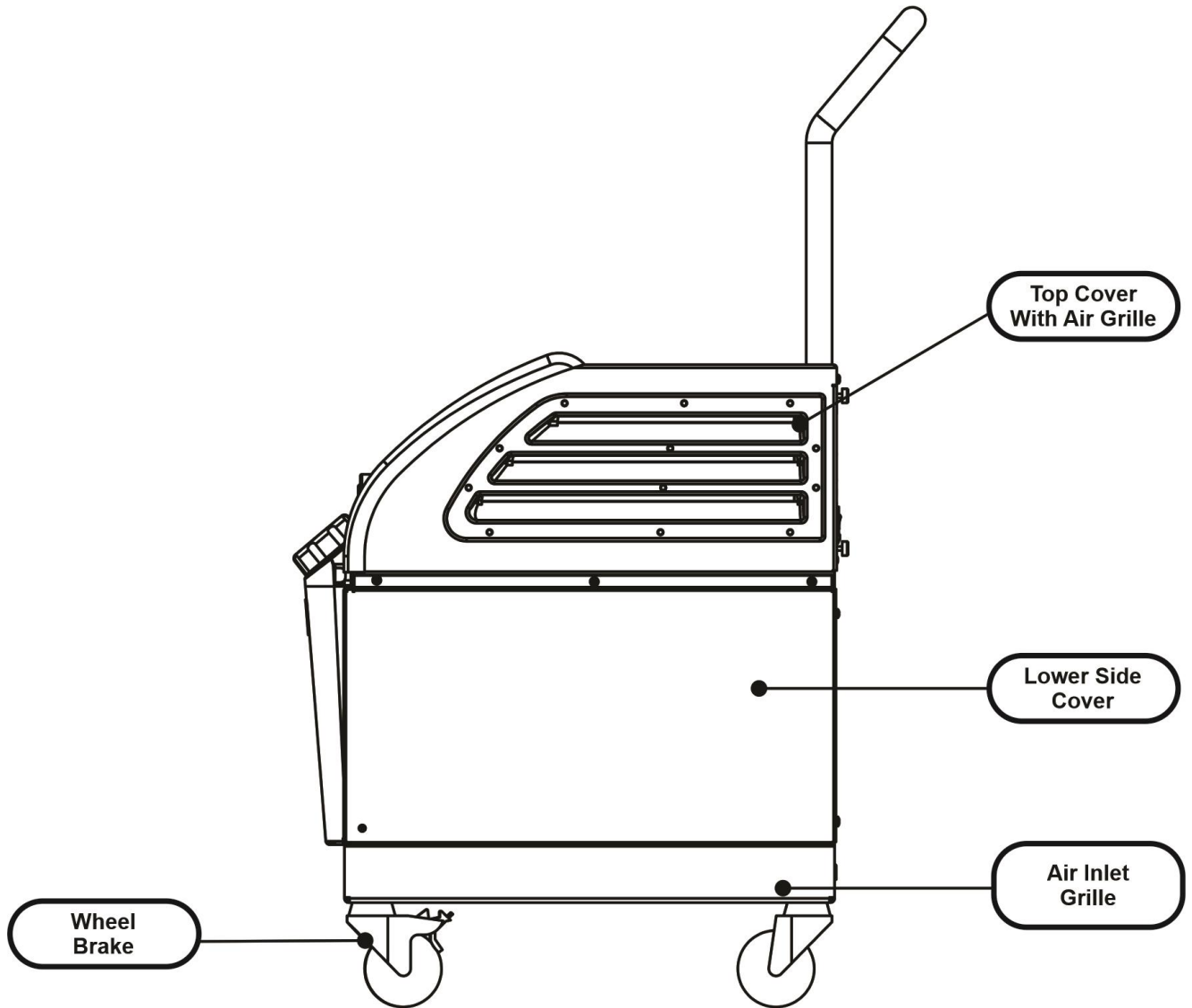

Figure 3: Side View

Rear Panel

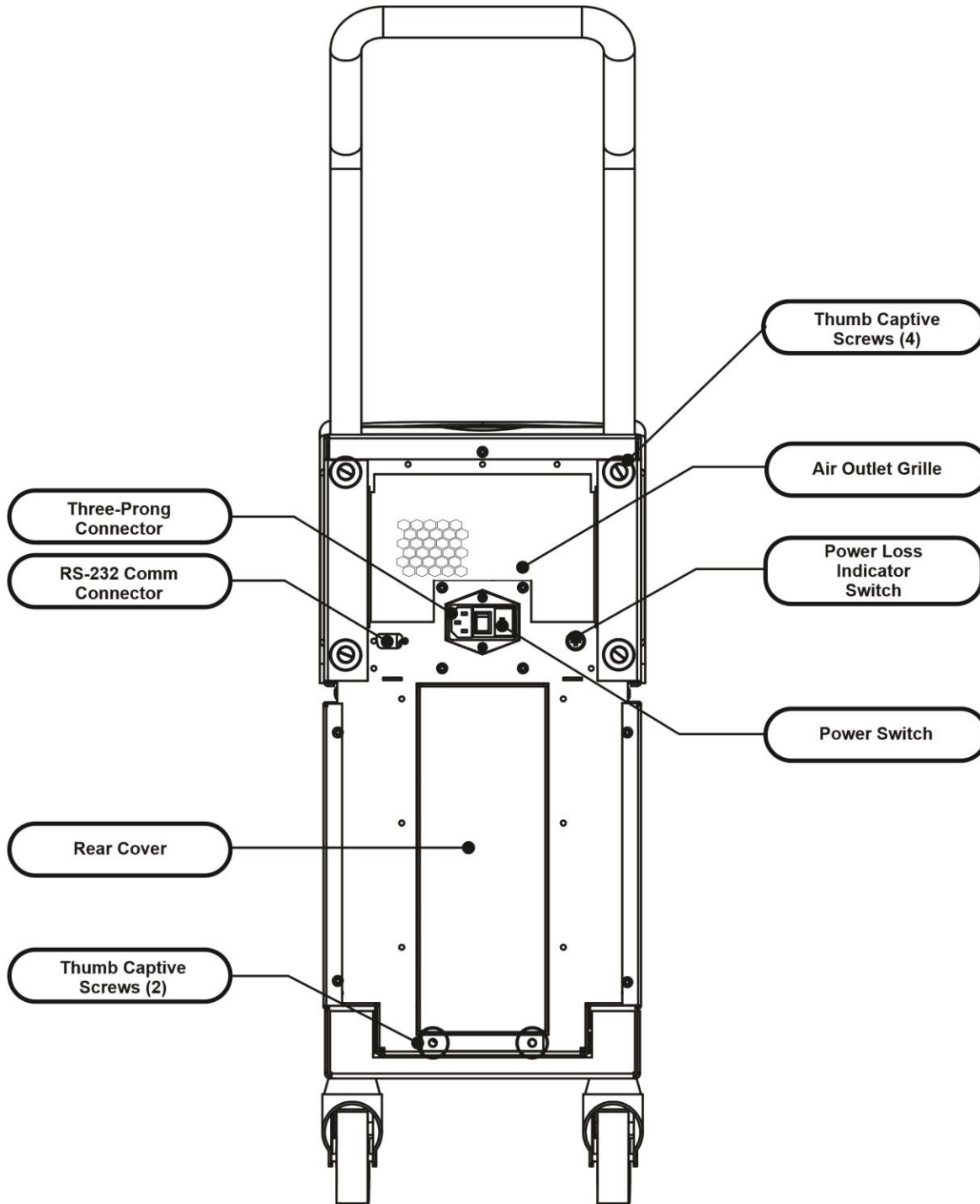

Figure 4: Rear View

ThermoWrap®

General

The ThermoWrap® is a one-piece wrap with one inflow and one return water connection. It is designed to facilitate the wrapping of individual parts of the body (chest, arms, thighs, etc.) to maximize surface coverage.

Description and Intended Use

The ThermoWrap® garment is a flexible heat exchanger through which the water circulates.

ThermoWrap® is:

- Disposable
- Biocompatible
- Latex free
- Antistatic
- Adjustable

Each section of ThermoWrap® is separately wrapped around the appropriate area of the patient (e.g. chest, arms and thighs) to ensure maximum body surface coverage.

The water's exit and entrance points are short sections of tubing integrated with a Quick Coupling Connector (QCC) and welded to convenient locations on the edges of the ThermoWrap®.

The ThermoWrap® design allows the physician to leave bare different body parts as dictated by the surgical procedure.

ThermoWrap® is available in a range of sizes and designs (depending on surgery type) to optimize body coverage.

ThermoWrap® is secured to the patient via pressure sensitive adhesive strips that adhere to the wrap.

CAUTION!! The wraps are designed for single patient use only. Reusing may cause cross contamination and/or irritation.

Wrap Material

- **Patient side:** Non-Woven Polypropylene
- **Exterior:** Brushed Loop Fabric

Usage Duration

The wrap is durable for up to 28 hours. It is recommended to replace the wrap if it becomes soiled.

Selected Wrap Design

Belmont Medical Technologies offers disposable ThermoWraps[®] in four different ThermoWrap[®] designs.

Cardiac ThermoWrap[®] is used for open-heart surgery or for complete access to the torso and legs. see Table 2

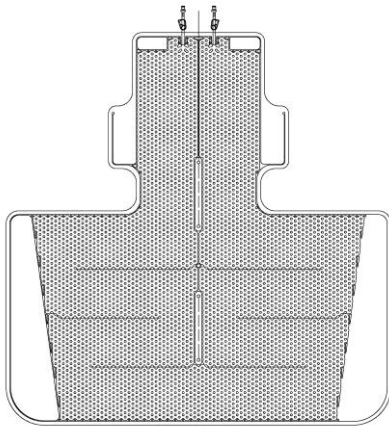

Figure 5: Cardiac ThermoWrap[®]

Universal ThermoWrap[®] is used for any typical surgery other than open-heart surgery. For available sizes, see Table 2.

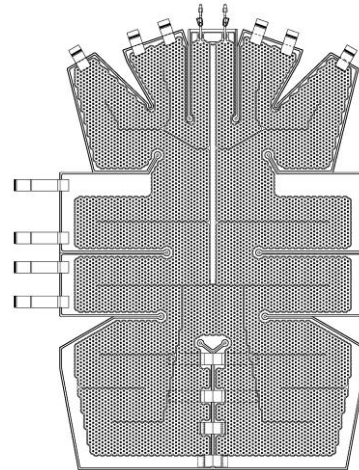

Figure 6: Universal ThermoWrap[®]

Universal (Pediatric) ThermoWrap[®] is used for pediatric surgery. For available sizes, see Table 2

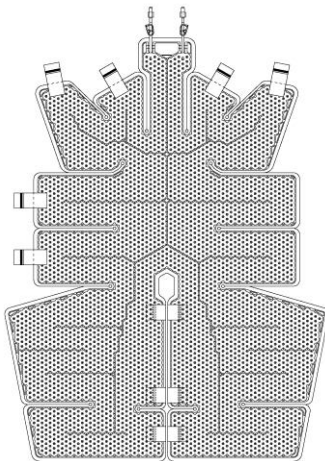

Figure 7: Universal (Pediatric) ThermoWrap[®]

Infant ThermoWrap[®] is used for infant surgery. It allows for covering the head. For available sizes, see Table 2.

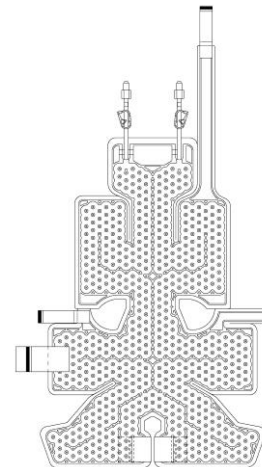

Figure 8: Infant ThermoWrap[®]

Figure 9: Infant ThermoWrap®

To determine the most suitable type of ThermoWrap® for the procedure, the following information is required:

- Patient height or infant weight (see

Figure 10)

- For adult: type of operation to be performed (cardiac or other)

The model type, model number, and sizes are listed on the label on each package. Choose the appropriate model and size according to the parameters listed above. If the patient's overall height or overall weight matches the maximum value of a specific model, use the next larger size.

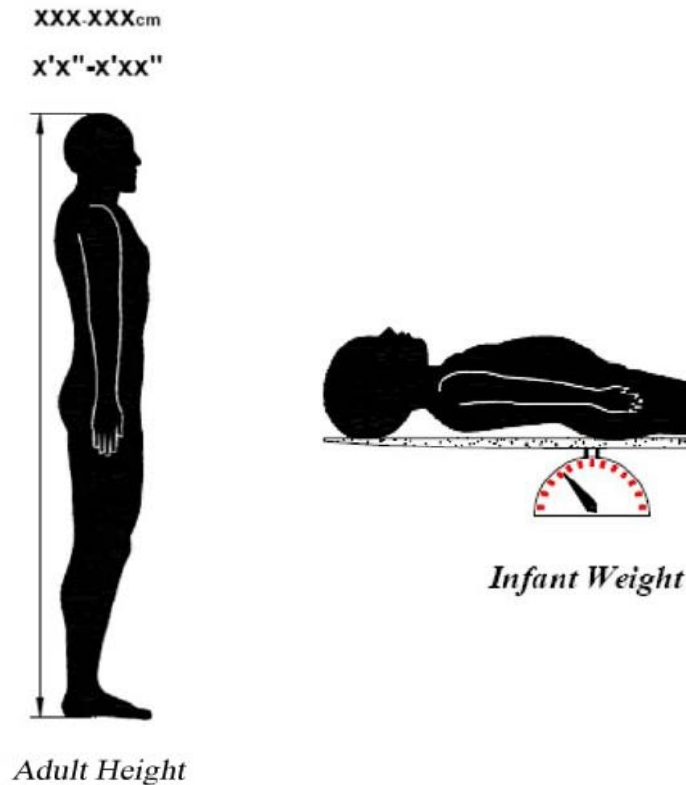

Figure 10: Measurements

Table 2: ThermoWrap® Sizes

	<i>Part number</i>	<i>Wraps per package</i>	<i>Patient size/ weight</i>	<i>Wrap length/ Width (m)</i>
ThermoWrap® Cardiac	512-03363	12/Box	Fits most adults	1.348/1.319
ThermoWrap® Universal	512-03166	12/Box	168-180cm	1.904/1.321
	512-03160	12/Box	152-168cm	1.934/1.295
	512-03153	12/Box	135-152cm	1.744/1.212
ThermoWrap® Universal (Pediatric)	512-03148	12/Box	122-135cm	1.582/1.193
	512-03141	12/Box	104-122cm	1.398/1.068
	512-03136	12/Box	91-104cm	1.225/0.841
	512-03131	12/Box	79-91cm	1.118/0.739
ThermoWrap® Infant	524-03125	24/Box	7-11 Kg	0.983/0.629
	524-03121	24/Box	4-7 Kg	0.698/0.604
	524-03118	24/Box	2.5-4 Kg	0.660/0.465

Accessories

The following accessories are needed to operate the Allon® system:

Temperature Probes

Intended Use

Core temperature probes are used to measure the patient's core temperature.

Surface temperature probes are used to measure the patient's surface temperature, in a location not covered by the wrap.

NOTE: Temperature probes can be either reusable or disposable according to country regulations.

NOTE: Reusable temperature probes are not applicable for US market or other select markets.

NOTE: All temperature probe response times are less than 60 seconds.

1. Reusable Temperature Probes

There are three color-coded temperature probes: Core (gray), Surface (green), and Infant Core (gray). Both core and surface temperature probes must be plugged into the Allon® device. The core temperature probe must be inserted into the patient and the surface temperature probe must be attached to the patient for the device to function properly.

CAUTION! Clean, disinfect, and sterilize the reusable temperature probes in accordance with the manufacturer's labelling. Refer to the manufacturer's user guide for details.

1.1. Reusable Core Temperature Probe

The core temperature probe (gray) measures core body temperature when inserted into the patient's body (either rectal or esophageal placement), and the plug of the probe cable is inserted into the gray core socket at the front of the Allon® device.

1.2. Reusable Infant Core Temperature Probe

The infant core temperature probe (gray) measures infant core body temperature when inserted into the patient's body and the plug of the probe cable is inserted into the gray core socket at the front of the Allon[®] device.

1.3. Reusable Surface Temperature Probe

The surface temperature probe (green) measures body surface temperature when attached to the patient's skin, and the plug of the probe cable is inserted into the green surface socket at the front of the Allon[®] device.

2 Disposable Temperature Probes

Disposable temperature probes are attached to two color-coded adapters: gray (Core) and green (Surface). Both adapters are reusable. The core temperature probe must be inserted, and the surface temperature probe must be attached to the patient for the device to function properly.

WARNING!!! Use only disposable probes supplied by Belmont Medical Technologies.

CAUTION! The sterilization of the disposable temperature probes are guaranteed by the manufacturer only.

CAUTION! Before use, check the packaging and expiration date of the disposable temperature probes. If the package is not sealed or probes have expired, avoid from using them.

NOTE: Refer to the probe and adapter manufacturer's instructions for use to determine expected lifetime for each accessory.

2.1. Disposable Surface Temperature Probe

The disposable surface temperature probe is attached to the reusable surface adapter (green). The adapter is plugged into the green surface socket at the front of the Allon[®] device. The temperature probe is attached to the patient's skin and measures surface body temperature. It should be placed on the skin not covered by the Wrap.

2.2. Disposable Core Temperature Probe

The disposable core temperature probe is attached to the reusable core adapter (gray). The adapter is plugged into the gray core socket at the front of the Allon[®] Device. The temperature probe is inserted into the patient (esophagus/rectum) and measures core body temperature.

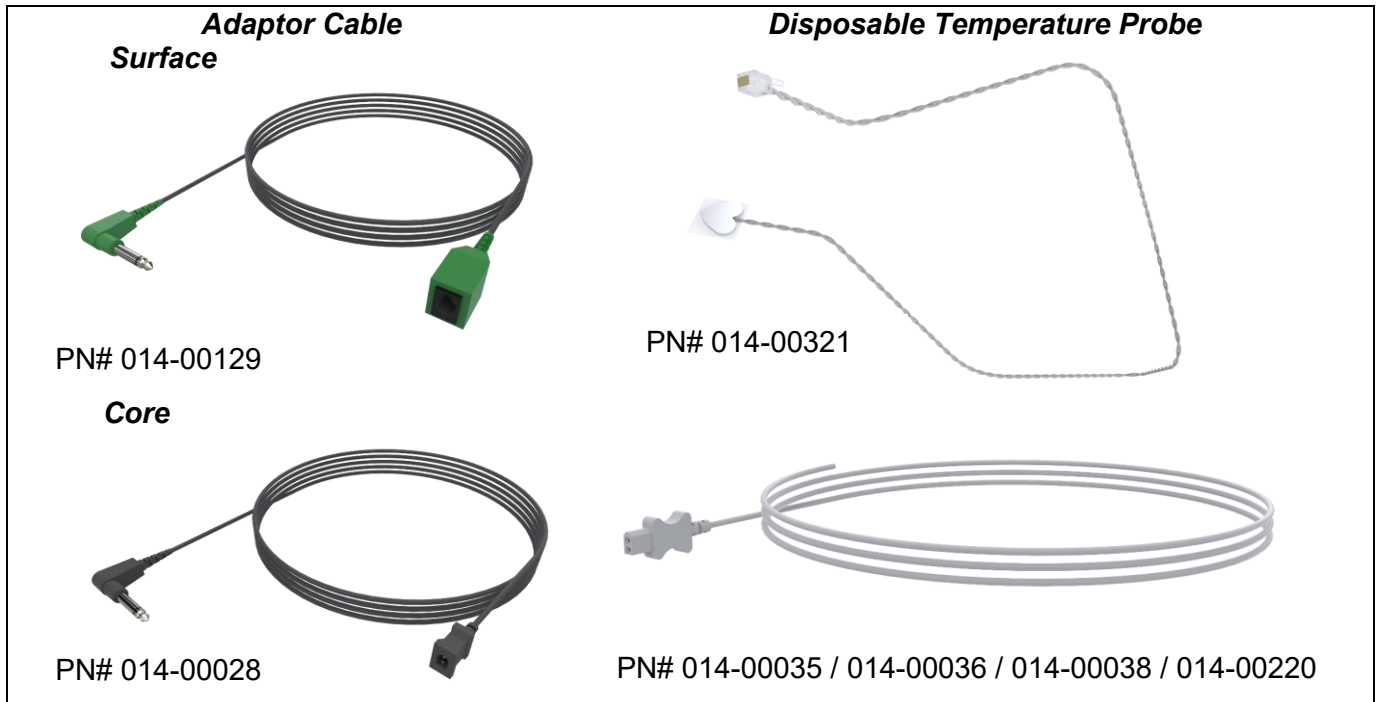

Table 3: Disposable Sensors

<i>Part number</i>	<i>Description</i>
Surface Temperature	
014-00129	Adaptor Cable for Disposable Surface Temperature Probe RJ, Green
014-00321	Disposable Surface Temperature Probe RJ (20/pack)
Core Temperature	
014-00028	Adaptor Cable for Disposable Core Temperature Probe, Gray
014-00035	Disposable Core Temperature Probe, 9 Fr, Smiths Medical ER400-9 (20/pack)
014-00036	Disposable Core Temperature Probe, 7 Fr, Metko FMT400/AOR-D2 (20/pack)
014-00038	Disposable Core Temperature Probe, 9 Fr, TE Measurement Specialties 4491 (20/pack)
014-00220	Disposable Core Temperature Probe, 9 Fr, DeRoyal 81-020409 (10/pack), USA ONLY

Table 4: Reusable Sensor and Data Provider Input Specifications

<i>Part No.</i>	<i>Name</i>	<i>Description</i>	<i>Accuracy</i>	<i>Resolution</i>	<i>Type</i>
014-00020	Core	Inner body temperature	± 0.3°C	± 0.1°C	Medical Grade Thermistor
014-00021	Surface	Skin temperature	± 0.3°C	± 0.1°C	Medical Grade Thermistor
014-00005	Core Infant	Infant Inner body temperature	± 0.3°C	± 0.1°C	Medical Grade Thermistor

3. Detachable Electric Power Cable & Plug

See Table 7, “Accessories Inventory”.

4. Connecting Tubes for Wrap

Two flexible 2.5m long connecting tubes connect the ThermoWrap® with the Allon® device to enable the flow of water between them. The tubes are supplied as a paired unit with two male Quick Coupling Connectors at the Allon® device end and with two female Quick Coupling Connectors at the ThermoWrap® end.



5. Male Connector for Draining Water

See Table 7, “Accessories Inventory”.

6. Spare Water Filter

For annual filter replacement (refer to Service Manual for instructions).

7. Handle

The handle is removable and is secured with four thumb screws on the back of the device. (See Figure 13).

8. Temperature Splitter (Optional)

The Temperature Splitter is compatible for the Allon® system using the YSI 400 Series temperature probes.

The Temperature Splitter measures the patient’s temperature using a single sensor in the patient, and displays the temperature on both the Allon® screen and an additional system, such as a monitor, eliminating the need to use two separate sensors.

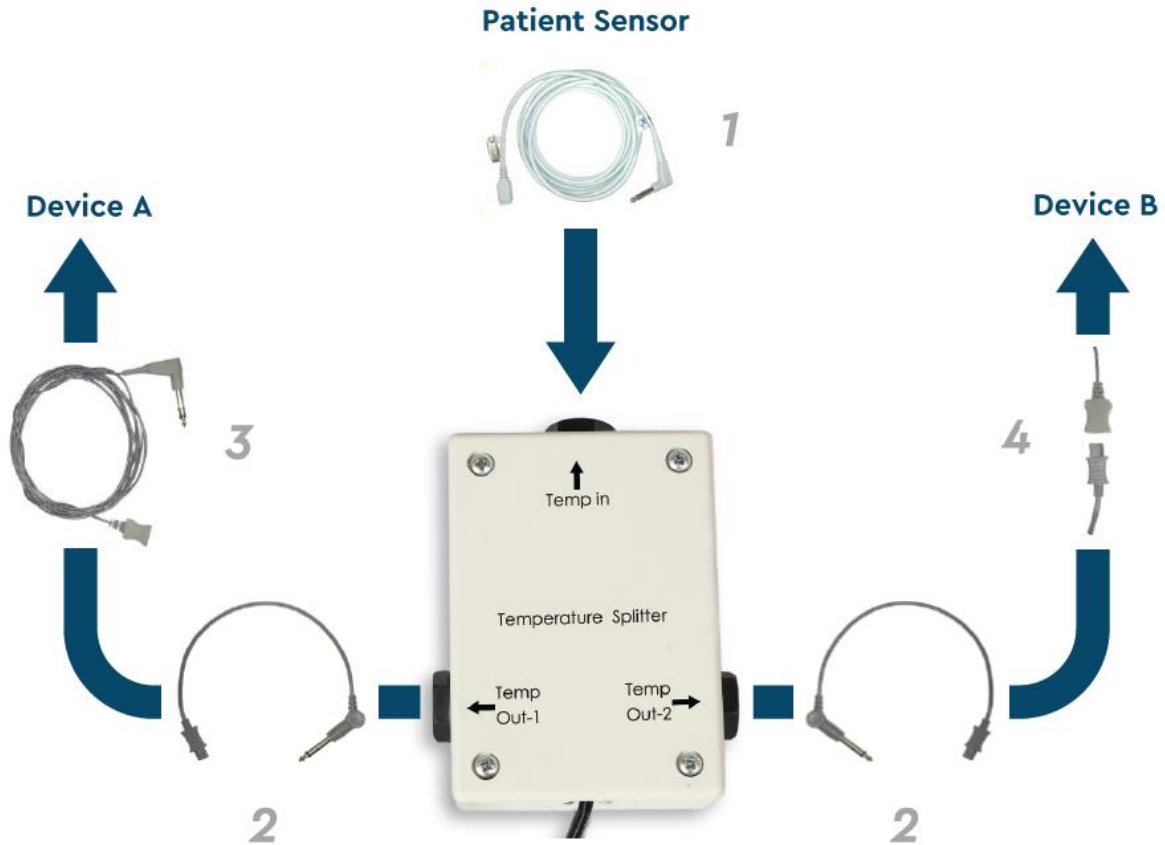

Figure 12: Temperature Splitter

System Specifications

See the following page for system specifications.

SPECIFICATIONS

This chapter lists and describes the technical specifications for the Allon[®] system and CliniLogger[™] accessory.

Allon[®] Technical Specifications	
Allon[®], one of Belmont Medical Technologies' patient temperature management solutions, is a servo-controlled, non-invasive thermal regulation system. Allon's algorithm-driven heat pump supplies heated water through the ThermoWrap[®] disposable patient wrap.	
Control Unit	
Physical Dimensions	Mobile Unit with 4 wheels and 2 brakes 260 mm W x 625 mm D x 940 mm H (10.23" W x 24.6" D x 37"H)
Net Weight	34 kg / 75 lb
Environmental Operating Conditions	
Temperature	5°C to 40°C (41-104°F)
Humidity	10 to 93%, non-condensing
Note:	Not intended to be used in an oxygen rich environment. Do not use in an atmosphere with flammable anesthetic mixtures.
Environmental Storage Conditions	
Temperature	-15°C to +68°C (5-154°F)
Humidity	10 to 93%, non-condensing
Hardware	
Electricity Input Power	230/115 VAC (Switchable) with isolation transformer 50/60 Hz
Maximum Power Consumption	690 Watts 230 VAC 3.0A 115 VAC 5.8A
Heat Exchangers	Peltier Technology - Thermoelectric Coolers (TECs)
External Ports	(1) Isolated Serial Port
LCD Display Size	144.8mm / 5.7" color display
LCD Display Resolution	320x240
User Interface	MultiCapacitive Touch Screen 5 soft push buttons
System Sensors	3 Internal Temperature Sensors: 1) Water In, 2) Water Out, and 3) Thermostat 2 Pressure Sensors
Water	
Water Type:	Sterile or 0.22 µ filtered water
Tank Capacity:	6 liters (1.6 gallon)
Pump Rate:	1.2 L/minute
Water Temperature Accuracy:	±0.3°C
Water Temperature (Outflow) Range:	13-40.8°C (55.4-105.4°F)
Patient Temperature	
Patient Temperature Channels	2 channels: 1) Core and 2) Surface
Patient Temperature Probe Accuracy	±0.3°C

Software	
Modes of Operation (continuous)	Normothermia Manual Mode Standby (No thermoregulation; monitoring only)
Patient Set Point Temperature	
Normothermia Mode Default	37.0°C
Target Temperature Range	30-40°C (adjustable in 0.1°C increments)
Water Set Point Temperature	
Manual Mode Default	38°C
Water Target Temperature Range	36-41°C
Adjustable Alarm Limits	High Patient Temperature Low Patient Temperature High Water Temperature
Displayed Information	Mode of Operation Care Time System Status and alarms Set Point Temperature - Normothermia Mode Water Out Temperature - Manual Mode Patient Core Temperature Patient Surface Temperature Temperature Graph Technician mode and display
Languages	
<ul style="list-style-type: none"> • English • Danish • Dutch • Finnish • French 	<ul style="list-style-type: none"> • German • Italian • Norwegian • Polish • Portuguese
<ul style="list-style-type: none"> • Russian • Spanish • Swedish • Turkish 	
ThermoWrap®	
Range of Sizes	40 cm – 196 cm
Duration of Use	up to 28 hours unless soiled
Wrap Storage	
Storage Span	5 years
Temperature Conditions	10°C to 27°C
Humidity Conditions	10-90%
Wrap Transport	
Temperature Conditions	-20°C to 60°C
Humidity Conditions	20-95%

CliniLogger™

CliniLogger™ is an optional accessory to Allon®/ CritiCool® / CritiCool® MINI Thermoregulation Systems. It is used to collect the system parameters during the thermoregulation procedure.



Hardware

Connector	DB9 connector for serial interfacing to Allon® or general PC
Size	35 x 65 mm
Controller	MSP4301611 Micro controller with the following features: <ul style="list-style-type: none"> – Built in Flash and RAM – Built in UART & SPI – Built in DMA controller
Memory	Flash memory capacity: 2 MB
Power Requirement	5 Volt DC supplied from the Allon® or general PC <ul style="list-style-type: none"> – <20 mA – <100 mW
LED	Bicolor (Green / Red)
Data Storage Rate	Every 1 minute into flash memory
Serial Communication	RS232: <ul style="list-style-type: none"> – 19200 bps to Allon® – 115200 bps to PC
Data Collected	Temperature: Set Point, Core, Surface Time Water Circulation ON/OFF Water Heat/Cool Mode of Operation Errors
CliniViewer Software	PC Application

Chapter 3: Installation

Pre-installation Requirements

Space and Environmental Requirements

The Allon[®] device is supplied on a trolley as a mobile unit for user convenience. It must be located no less than 5 cm (2") from other objects to avoid the impairing of ventilation to the Allon[®] device.

The following dimensions should be considered when placing the Allon[®] device:

260 mm W x 625 mm D x 940 mm H / (10.23"W x 24.6"D x 37"H)

Electrical Requirements

115/230 VAC 690 Watts

CAUTION! Verify that the voltage switch is set for the local voltage.

Unpacking and Inspection

The Allon[®] device has undergone full quality assurance testing before shipment and should be operational upon delivery.

The unit should be unpacked, installed and tested only by Belmont Medical Technologies' authorized personnel. No attempt should be made by the purchaser to unpack or assemble the unit alone.

NOTE: Report any container damage prior to opening the container, or any unit damage prior to unpacking, installation, or testing to your Belmont Medical Technologies distributor.

Unpacking Allon From the Box

Upon arrival, check the SHOCKWATCH® and TIP-N-TELL® indicators.

If either has been activated, immediately open the package and check for external damage. If the device has been damaged, photograph the damage and immediately notify the shipping carrier and/or Belmont Medical Technologies at techservice@belmontmedtech.com, being sure to provide all relevant information, including evidence of the damage.

1

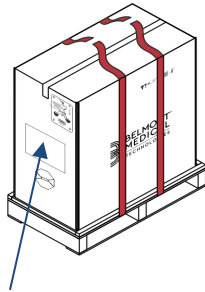

Unpacking instructions are affixed to the box.

Please refer to instructions on the box.

2

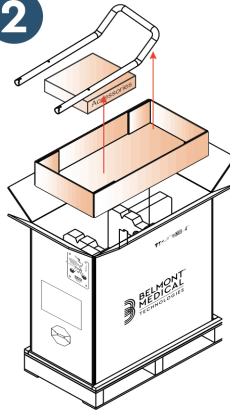

3

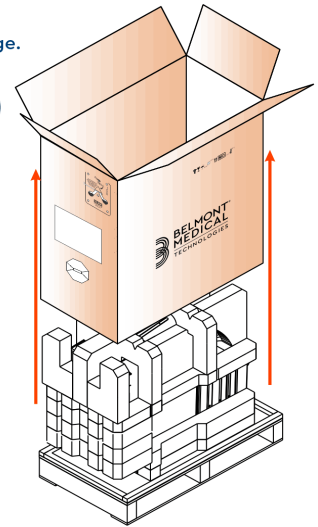

Keep the original box.

4

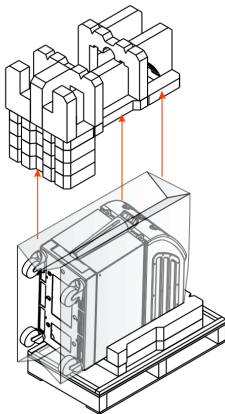

5

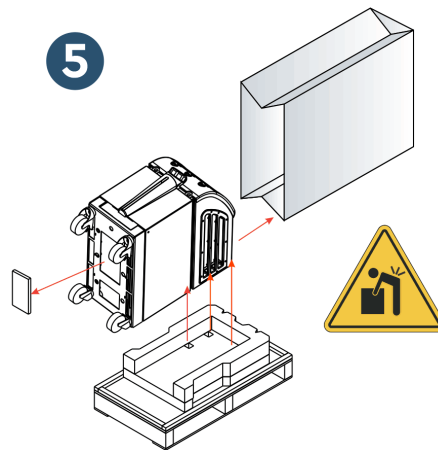

6

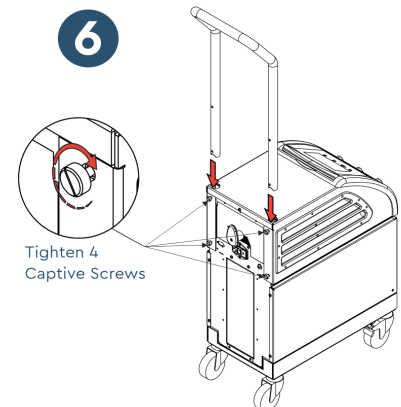

Assembling the Handle

1. To assemble the handle:

1. Release the four thumb screws by hand.
2. Slide the two ends of the handle into the holes in the top cover (pay attention to the direction of the curve in the handle) until the handle is inserted all the way in (see Figure 13).
3. Press in and screw by hand the four thumb screws (do not use force when tightening) to secure the handle and the top cover.

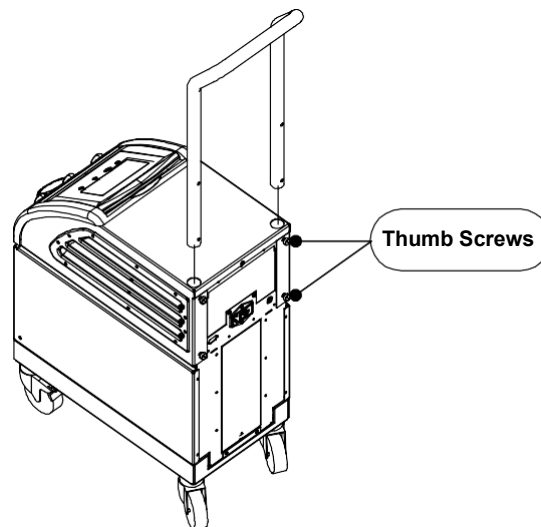

Figure 13: Handle Assembly

Equipment List

The Allon[®] system includes the following:

- Allon Device
- Spare Filter
- Power Cable
- User Manual
- Quick Reference Guide
- Accessories Kit for Allon – one of the following:
 - 200-00400 Adult Accessory Kit with Reusable Temperature Probes
 - 200-00410 Accessory Kit for Disposable Temperature Probes
 - 200-00420 Infant Accessory Kit with Reusable Temperature Probes

Moving the Unit

Preparation:

Before moving the unit:

1. Ensure that the Allon® device is off by pressing the ON / OFF switch.
2. Ensure that all electrical connections are disconnected.

Locking and Unlocking the Trolley Wheels

The Allon® device trolley has four wheels. The front wheels are fitted with a brake. The brake lever is located over the wheel. To lock the wheels, firmly press the lever. To release the wheels, lift the lever.

When the unit is stationary, the brakes must be in the locked position. Release the brakes only when transporting the unit.

Packing Allon for Shipment

Please follow these instructions to properly prepare Allon for transport. Empty the water tank prior to packing Allon.

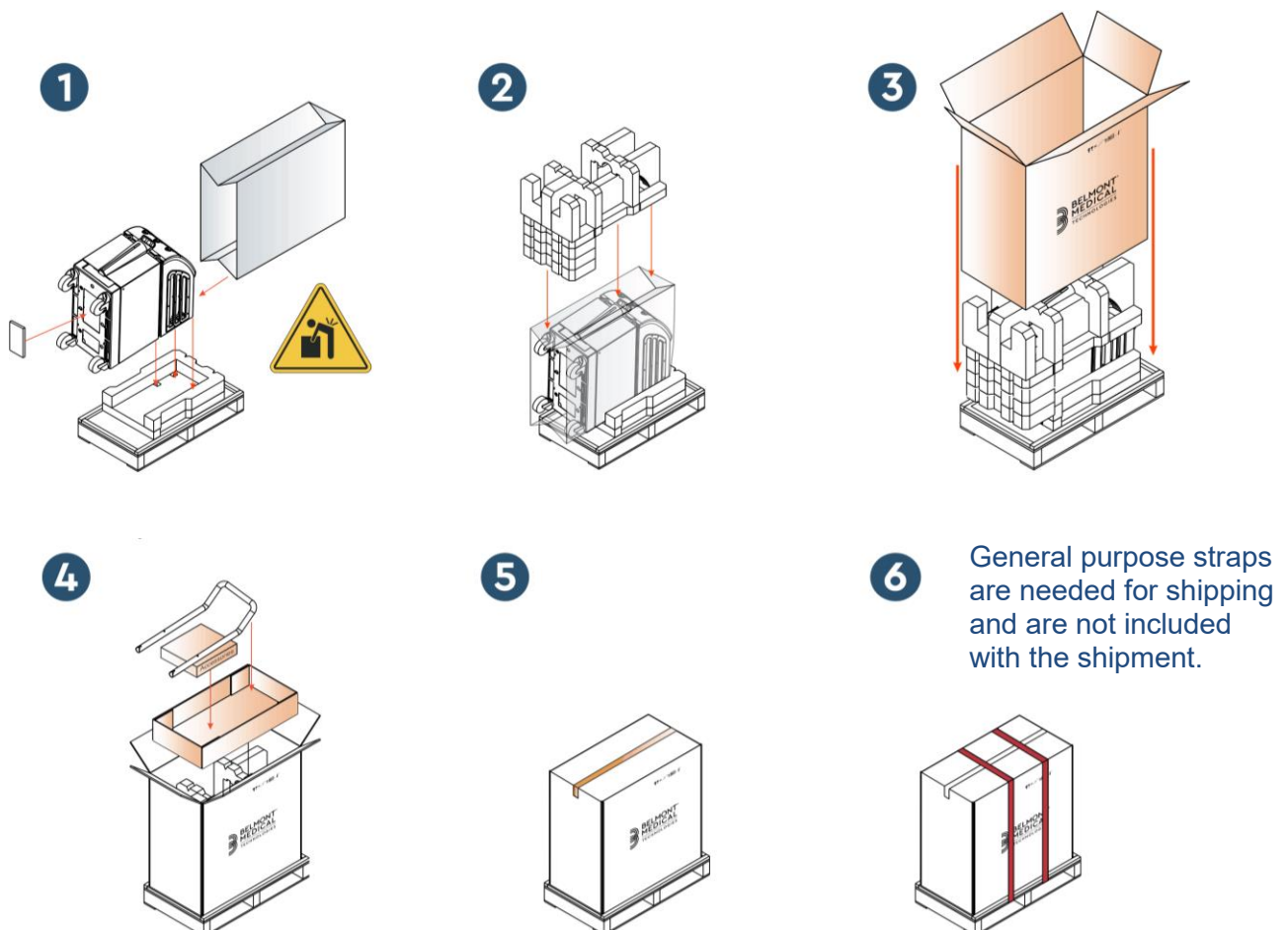

Chapter 4: Operating Instructions

General

This chapter contains:

- A description of the controls, indicators, and connections for the Allon® device.
- Detailed operating instructions for the Allon® system.

Controls, Indicators and Connections

Included in this section is a short description of the following:

- Main Power Switch
- Power Loss Alarm Disable
- QCC – Quick Coupling Connectors
- Sensor Sockets
- Control Panel
- Indicators
- Displays

Main Power Switch

The main power switch, located on the rear side of the unit, switches the Allon® device ON and OFF.

Power Loss Alarm Disable

The silver push button to the right of the main power switch on the back of the unit turns off the yellow LED on the front of the unit. This LED will flash each time the machine is powered down, loses power or is unplugged, and it will continue for approximately 10 minutes or until the disable button is pressed.

QCC— Quick Coupling Connector

The Quick Coupling Connectors are located at the front of the Allon® device and are connected to the ThermoWrap® by means of the connecting tubes for wrap.

1. To connect the Tubes:
 - a. Lock the connecting tubes by pressing the metal ends of the tubes into each metal connector on the device. When locked, a clicking sound is produced.
 - b. Verify that the tubes have been locked by lightly tugging them towards you.
2. To disconnect the Connecting Tubes:
 - a. Press the metal flange and pull out the connecting tubes.

Temperature Sockets

There are two temperature probe sockets located at the front of the Allon[®] device.

- Core – for core temperature probe
- Surface – for surface temperature probe

NOTE: All instructions regarding the reusable temperature probes are NOT applicable for the USA market or other select markets.

Control Panel

The adjustable control panel is located at the top of the Allon[®] device. Once the Allon[®] device is turned on, all operating functions are controlled through the control panel.

Allon[®] has a touch screen, with the following operational keys:

- Four touch keys
- Five press keys to the right of the touch panel

The machine can be operated by either the touch or press keys.

NOTE: The alarm icon is an informative icon only. In order to silence an alarm, you must press the hard key of the alarm, located to the right of the panel.

The control panel's simple soft-touch keys and visual displays guide you through each operational phase.

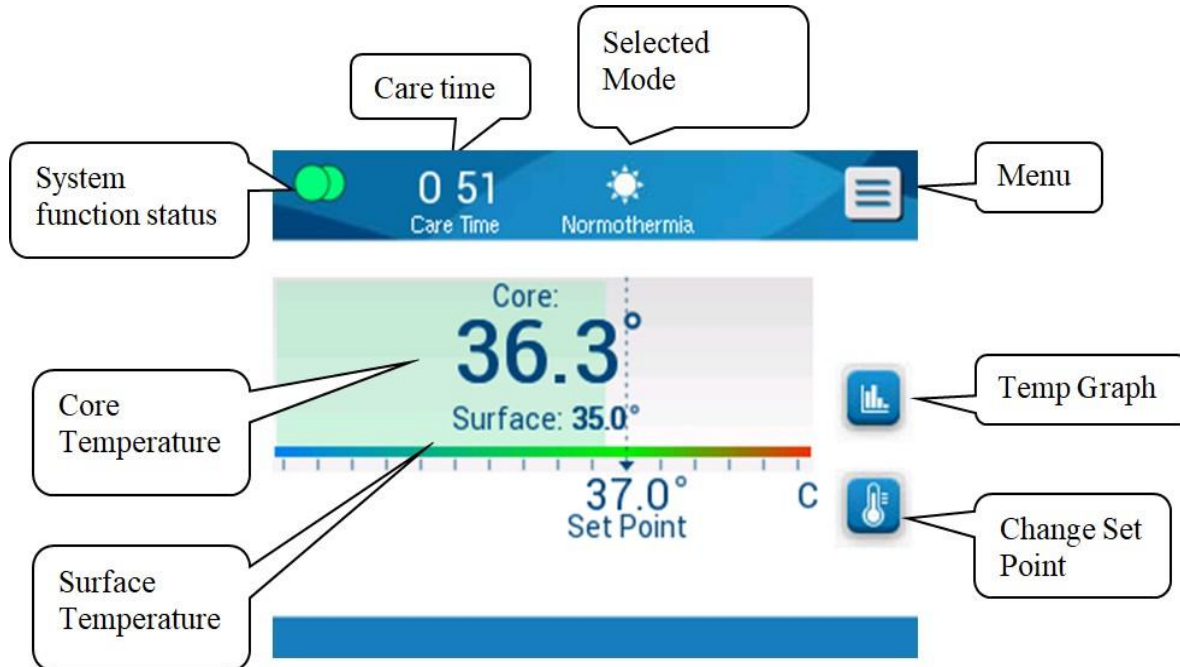

Figure 14: Control Panel

Getting Started

Preparing the System for Operation

To prepare the system for operation:

1. Place the unit in the desired position according to Space and Environmental Requirements in Chapter 3.
2. Press the brake pedals and lock the wheels to secure the Allon[®] device.
3. Remove the water tank feeder cover and pour in sterile water or 0.22 μ filtered water until the maximum allowable level is reached.

CAUTION! Do not use deionized water or water created through reverse osmosis because it may promote corrosion of the metal components of the system.

NOTE: Use only sterile or 0.22 μ filtered water.

4. Observe the water-level indicator to prevent overfilling the water tank. Close the water tank cover.

NOTE: In case of overfilling, see Table 10.

5. Connect the Allon® device to the power source.
6. Power on the Allon® device, which will initiate the Self-Test.
(See *Turning on the System*.)

Turning on the System

To turn on the system:

1. Turn the main switch, located in the rear of the unit, upwards to the ON position. Once power is supplied to the Allon® device, the unit performs a self-test.

The self-test is performed in order to ensure the proper functioning of the Allon® device. A self-test is conducted every time the system is restarted.

In the event of a power failure of less than 10 minutes, the self-test will not be performed and the Allon® device will remain in operation mode.

During the self-test, the “Performing Self Test” message appears until the system is ready.

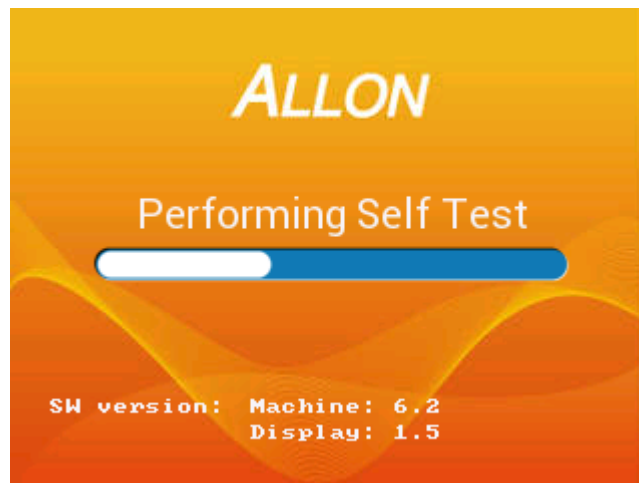

Figure 15: Initial Self-Test Screen

Successful completion of the self-test indicates that the Allon® device is ready to operate.

CAUTION! Whenever the Allon® device is activated, a self-test must be performed. Do not interrupt the self-test and wait until it is finished.

NOTE: During the Self-Test, the machine and display software versions are shown.

The self-test checks the functionality of the following components:

- Screen and Alarms
- Pump
- ThermoWrap® Connection
- Pressure Meter
- Heating and Cooling Unit
- Temperature of Water Inflow and Water Outflow

Self-Test Messages

If there is a failure during the self-test, a message appears, and the Allon® does not proceed to operation mode. See Chapter 7 “Troubleshooting” for details.

NOTE: Some of the messages will halt the Allon® device. Other messages allow the completion of the self-test but display the actions you need to take to correct the message state.

Pre-heating Water

After the self-test is completed, the system heats the water. Allow the Allon® to complete the Preheating Water process. The system will automatically start to flow water into the ThermoWrap® and enter the Normothermia Mode.

NOTE: Allon can prewarm the wrap from 23°C to 37°C in less than 5 minutes. Preheating water can take up to 15 minutes.

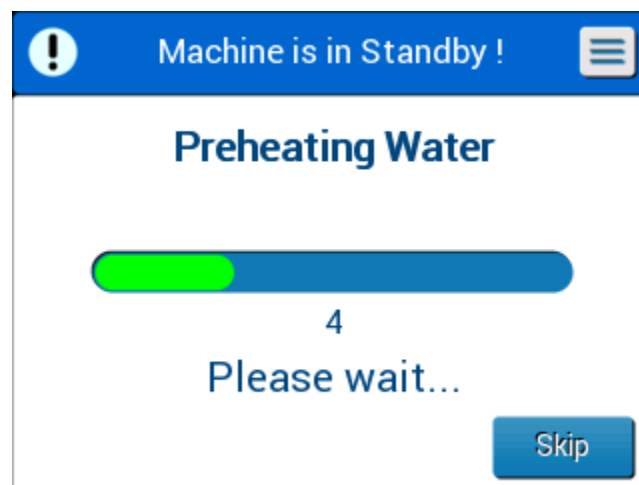

Figure 16: Preheating Water

7. Choose the appropriate model and size of the ThermoWrap® (see

Selected Wrap Design).

8. Place the ThermoWrap® on the operating table as described in the leaflet enclosed with the ThermoWrap® (see *Connect ThermoWrap® to Allon®*).

Connect ThermoWrap® to Allon®

1. After selecting the appropriate wrap and placing the wrap on the operating table/bed as described in the leaflet enclosed with the ThermoWrap®, confirm that the tubes have not twisted or bent.
2. Connect the water tubes to the wrap and to the Allon®. The wrap will automatically fill up, provided the self-test has completed.
3. Check that the clamps on wrap are open. If a clicking sound is heard, check for an obstruction of water flow at the wrap tubing connection or in the connecting water tubes. Refer to the Instructions for Use wrap leaflet supplied with each wrap.

WARNING!!! Water may drip from the inlet tubes of the wraps. Be sure that no electrical device or outlet is located under the device's water inlet or wrap tubes. When disconnecting wraps, confirm that the clamps are tight to prevent water leakage from the wrap.

9. Connect the connecting tubes to the Allon® device.
10. Water will flow into the wrap upon wrap connection and completion of the Self-Test.
11. Once the wrap has filled with water, the patient can be positioned on the wrap. (See *Preparing the Patient*.)

Preparing the Patient

1. Once the wrap has filled, the patient can be placed on the wrap. Follow the instructions for use wrap leaflet included with every wrap to confirm correct shoulder placement.
2. As long as the wrap has filled, the patient may be fully wrapped when convenient according to the instructions for use wrap leaflet included with every wrap. If using the Cardiac ThermoWrap®, while prepping the patient, the side portions of the wrap can be draped

over the patient's chest and abdomen to warm the patient. Then the wrap can be repositioned as needed for the surgical procedure upon completion of patient preparations.

NOTE: Until the patient's core temperature probe has been inserted into the patient and Allon reads a valid core temperature, the water temperature flowing into the wrap will have a set point temperature of 38.5°C. Automatic temperature adjustments as determined by the physician will not be made until the core temperature probe has been inserted into the patient.

CAUTION! If the wrap is soiled, replace the wrap.

12. Connect temperature probes and/or temperature adapter cables to the patient and Allon® device.

Inserting and Attaching Temperature Probes

CAUTION! For proper use of the Allon® device, the core temperature probe must be inserted into and the surface temperature probe must be attached to the patient.

NOTE: Reusable temperature probes are not applicable for US market or other select markets.

To connect the temperature probes:

1. Insert the core and surface temperature probes or adaptor cables (Disposable or Reusable) into their sockets, matching green to green (surface) and gray to gray (core).
2. Insert the Core temperature probe (reusable or disposable) into the patient's rectum or esophagus as soon as possible.
3. Attach the Surface temperature probes (reusable or disposable) to an exposed area of skin with adhesive tape.
4. Update temperature, preferences and/or other settings as needed. (See Main Screen.)

WARNING!!! The patient must be under constant supervision. Mishandling of temperature regulation equipment can potentially injure a

patient.

NOTE: The disposable temperature probes need to be connected to an adapter. Make sure to connect the appropriate probe to its corresponding adapter (note the color coding and connection type of the adapter).

NOTE: For proper use of the Allon® device, the core and surface temperature probes must be inserted per the instructions found with the probes. The location of the surface temperature probe is a clinical decision. All temperature probes directly measure temperature.

Main Screen

After the Preheating Water step is completed, the system automatically enters the main screen (default Normothermia Mode). Use the Setting screen to configure your default settings – see *Settings*.

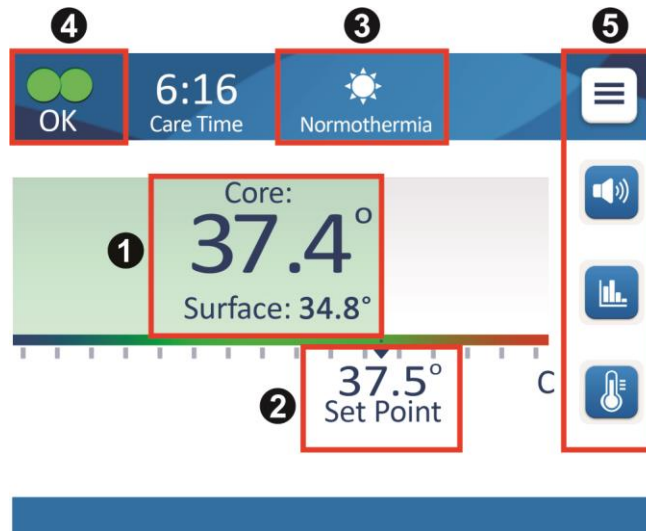





Figure 17: Main Screen- Default Normothermia

The Main Screen displays the following:

- Patient Core and Surface Temperatures ①
- Set Point Temperature ②
- Operational Mode ③
- OK indicator to indicate that the system is functioning correctly ④
- Action Icons and Touch Keys ⑤:

- Menu  / Escape 

- Graphical Display of Allon® Parameters 
- Set Point Temperature Control 
- Alarm ON / OFF 

NOTE: The Alarm icon appears only if there is an Alarm condition. This icon is informative only and not an action button. (It is not a touch button; the soft key alarm button must be pressed to silence alarms).

Menu Options

Touch the Menu icon  and select from the following options:

- Standby
- Select Mode
- Temp. Graph
- Settings
- Services

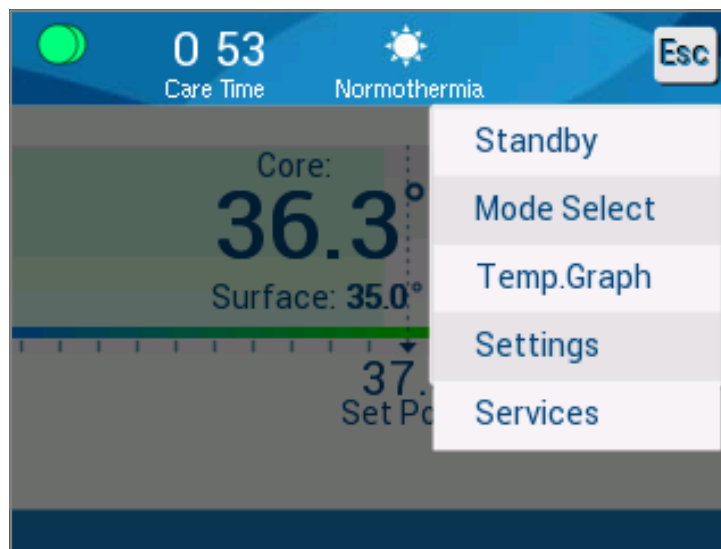



Figure 18: Menu Options

Standby

The Standby Mode is used to stop the water flow and the thermoregulation. Allon® still monitors the patient temperature while in Standby mode. The Allon® device circulates the water internally and maintains the water temperature at the appropriate level to be ready when returning to operational mode.

NOTE: During Standby Mode, there is no temperature regulation and therefore the patient temperature is not being controlled by Allon when Standby Mode is in use. Use this mode when replacing the wrap or when the wrap needs to be disconnected temporarily from the machine.

To access Standby Mode:

1. Touch the MENU icon .
2. Touch **Standby**.

During Standby mode, a message displays showing only the patient's temperature.

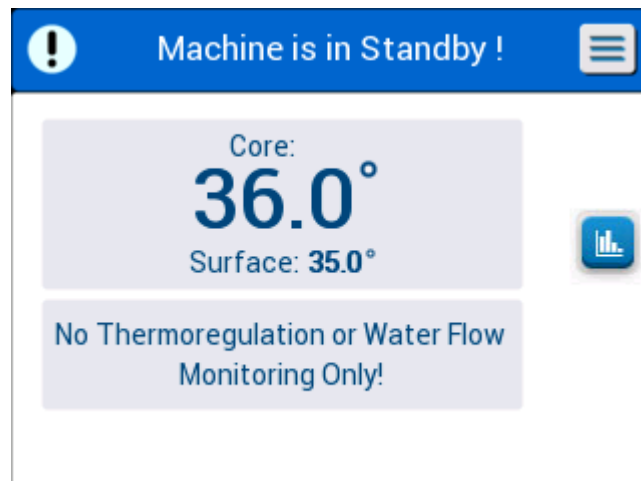

Figure 19: Stand-by Mode

Mode Select

Mode Select allows you to choose between Normothermia mode and Manual mode. Select the mode you want to use and touch OK to confirm.

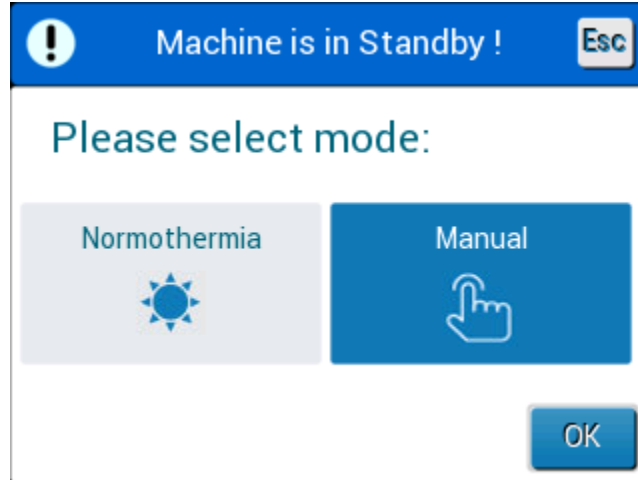

Figure 20: Mode Select

Normothermia Mode

This is the default mode. During this mode, the system gets feedback from both the patient's and the water's temperature, and adjusts the water temperature accordingly, in order to reach and maintain the patient's Set Point temperature.

The default set point temperature is 37°C (98.6°F).

In this mode, the user can change the Set Point Temperature.

CAUTION!! The desired set point temperature should only be set by the physician or under the order of a physician.

The Normothermia range is between 36°C and 38°C. Lower or higher temperatures are indicated on the bar in red.

To change the Core Temperature Set Point:

1. Touch the temperature icon . A temperature bar appears on the screen.

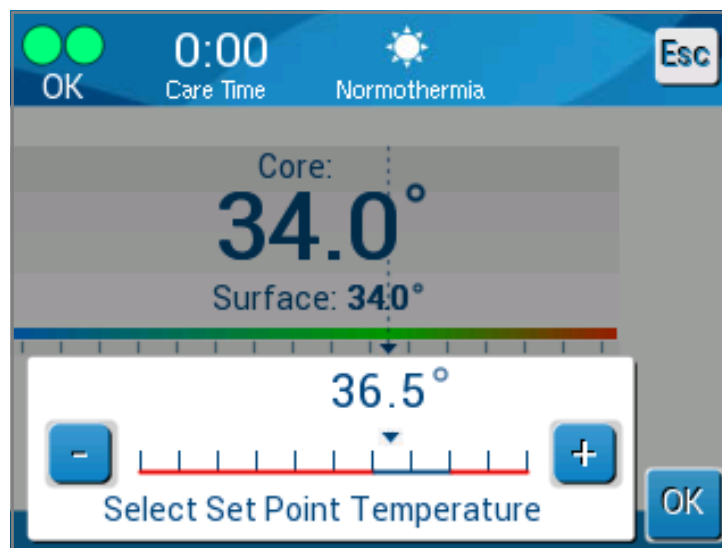





Figure 21: Select Set Point Temperature

2. Touch the arrow keys  /  or the bar scales on the screen in order to change the set point temperature.

NOTE: The  /  icons provide a change of 0.1°C. Each bar scale provides a change of 1°C. The temperature can be adjusted from 30 to 40°C.

3. Touch **OK** to confirm the selected temperature.

NOTE: When there is a difference between the set point temperature and the core temperature, a further increase in the set point temperature will not affect the water temperature in the ThermoWrap®. For example, if the core temperature is 36°C (96.8°F) and the set-point temperature is 37°C (98.6°F), raising the setpoint of the Allon® system further will not affect the water temperature. The Allon® device automatically operates at the optimal level to obtain the desired set-point temperature.

NOTE: The default setting is intended to maintain normothermia. However, the system provides the physician with the option of selecting a body temperature in the range of 30°C to 40°C (86°F-104°F).

NOTE: After the normothermia mode is selected, it takes up to 4 minutes for the system to reach equilibrium and start adjusting the patient's temperature according to the programmed rewarming step. This is due to variables in the environment: clinical, medicinal, and patient.

If the desired set point temperature is set to be out of normothermia range (36°C-38°C / 96.8°F-100.4°F), the message “**Out of Normothermia Range**” appears. Touch **OK** to confirm the selected temperature.

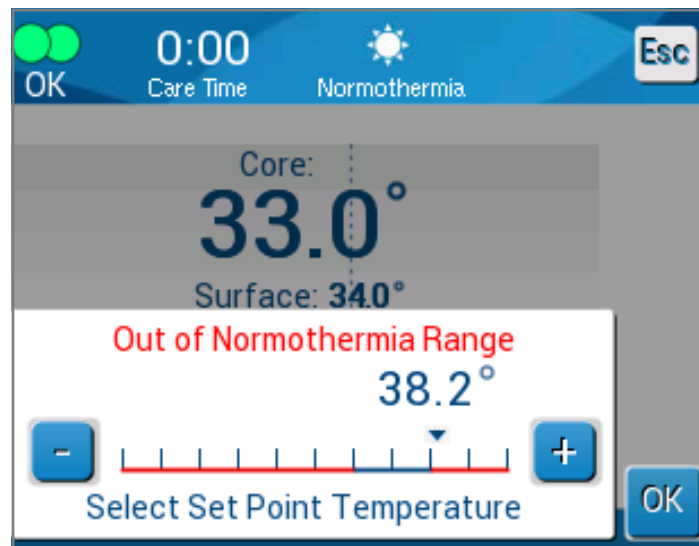

Figure 22: “Out of Normothermia” Message

Manual Mode

In Manual Mode, the system adjusts to a pre-determined water temperature, instead of the patient's Set Point Temperature.

NOTE: In Manual Mode, the water out temperature appears as set point in the Temp Graph.



Figure 23: Manual Mode Screen

The Manual mode allows the selection of the water temperature to flow inside the ThermoWrap®. The water temperature selection range is 36°C-40°C (96.8°F-105.8°F).

NOTE: Alarms and warnings are the same as in Normothermia mode.

Temperature Graph

This option displays up to 11 days of a graphic readout of the patient's core temperature on an hourly scale.

Use the Temp Graph icon  or the menu panel, to enter the graphic display of the current or last session.

The Allon® displays the current case parameters. If the wrap or the Temperature Probe/Adapter Cable is not connected, the last case will display.

The Temperature Graph presents the core, surface and set point temperatures of the case.

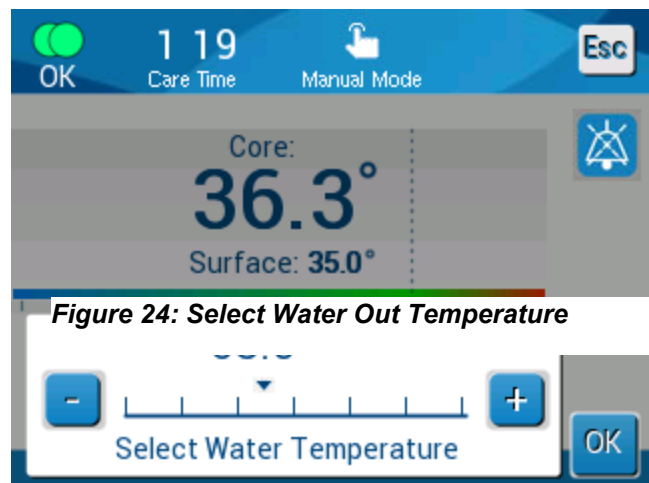

Figure 24: Select Water Out Temperature

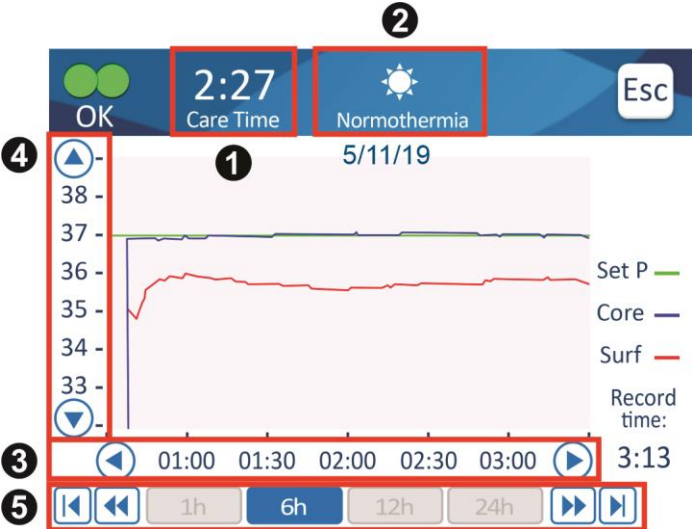
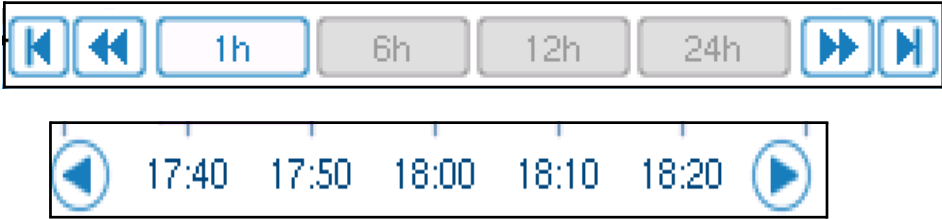

Figure 25: Temp Graph Mode

- The graphic display includes the following:
- The Care time and date are displayed at the top of the graph ①.
 - The operation mode is displayed at the top of the graph ②.
 - The time from the beginning of the procedure is displayed on the X axis ③.
 - The temperature is shown on the Y axis ④.
 - Use the arrows on the screen to scroll back to beginning of the case and to select the temperature range ③.
 - The screen can show 1 hour, 6 hours, 12 hours or 24 hours of a procedure. Use the double arrows to select the time range ⑤.



The Surface Temperature graph can be displayed or hidden by touching the **Surf** key.



To return to the Operations screen:

1. Touch the Escape  icon.

NOTE: When entering Temp Graph mode from Standby Mode, the Allon[®] device returns to Standby mode when touching Esc.

Settings

To configure settings:

1. Select the Setting section in the Menu.
2. To enter the Settings screen, you need to enter a 4-digit password, known only to trained authorized personnel.

Password (write in the box):

After entering the correct password, the Settings screen appears.

3. Select the parameter you want to configure by touching the buttons on the screen.
4. Touch **OK** at any time to confirm selection and to return to the operational mode.

The Settings screen is divided into three sections and enables the operator to configure various parameters.

Section 1:

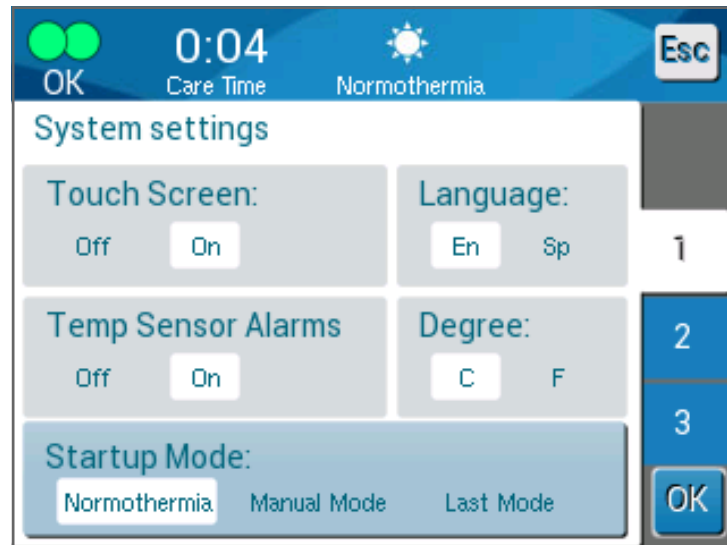
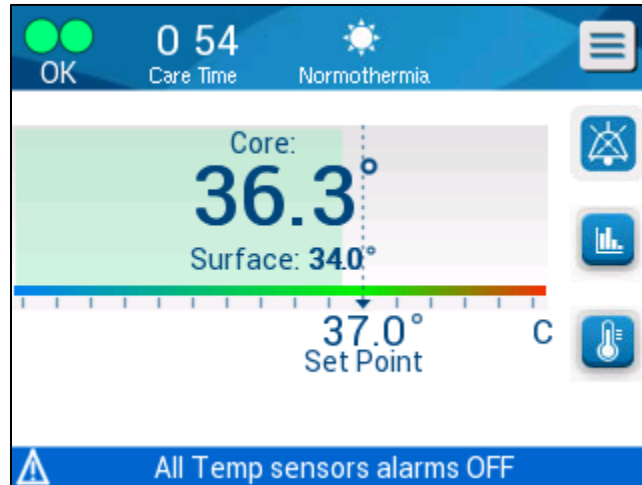

Figure 26: Settings Screen

The Settings screen enables the following:

- **Touch Screen:** Off/On- enables or disables the use of the of the touch icons.
- **Language:** The Language setting allows you to change the language of the control panel interface.
- **Temp Sensor Alarms:** This setting allows you to disable the following alarms:
 - “Patient temperature too high”
 - “Patient temperature too low”
 - “Water temperature too high”
 - “Water temperature too low”
 - “Core readout too low”
 - “Connect surface sensor”
 - “Connect core sensor”
 - “Check surface sensor”
 - “Check core sensor”

CAUTION! It is not recommended to turn Alarms off. Only a physician should choose the Temp Sensor Alarms Off option. Once setting the Temperature Sensor Alarms to Off, a constant blue message



appears on the main screen.

- **Degree:** Select temperature unit presentation: Centigrade or Fahrenheit.
- **Start up mode:** Select the default operational mode upon startup:
 - **Normothermia** – Normothermia mode (recommended)
 - **Manual** – Manual mode
 - **Last Mode** – Last operational mode that was in use

Figure 27: All Temp Sensors Alarm Off Indicator

Section 2: Adjustable Alarm Limits

Adjustable alarm limits allow you to adjust the alarm limits which will trigger an alarm in the system.

The adjustable alarms are:

- High Patient Temperature
 - Range from 38°C to 40°C in 0.5°C steps
- Low Patient Temperature
 - Range from 30°C to 35°C in 0.5°C steps
- High Water Temperature
 - Range from 36°C to 42°C in 0.5°C steps

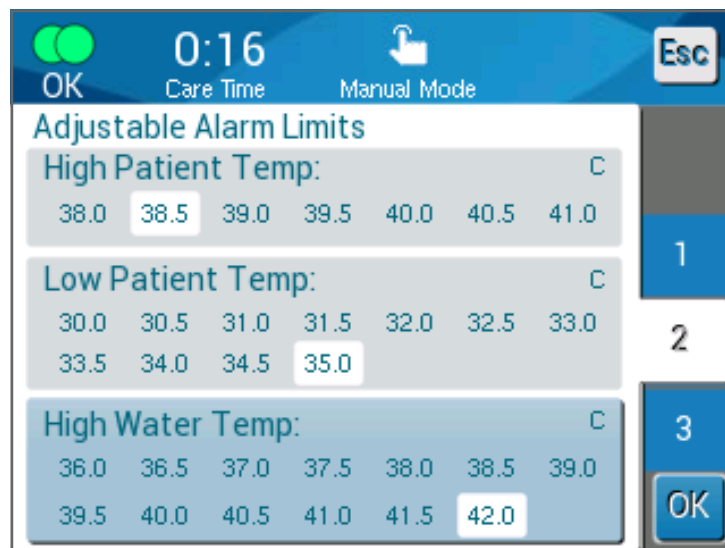

Figure 28: Adjustable Alarm Limits

NOTE: Changing the alarm limits should occur only under order of a physician.

NOTE: Once the alarm limits are set, the limits remain fixed and will not return to defaults.

Section 3: Set Date and Time

This section allows you to adjust the date and the time of the system.

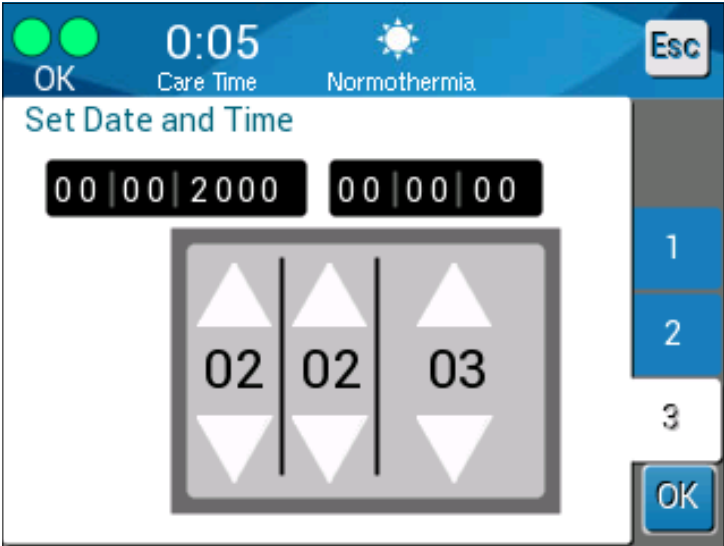

Figure 29: Set Date and Time

Services

Service menu enables choosing one of the following options:

- Empty
- System Check
- Technician
- Self Cleaning

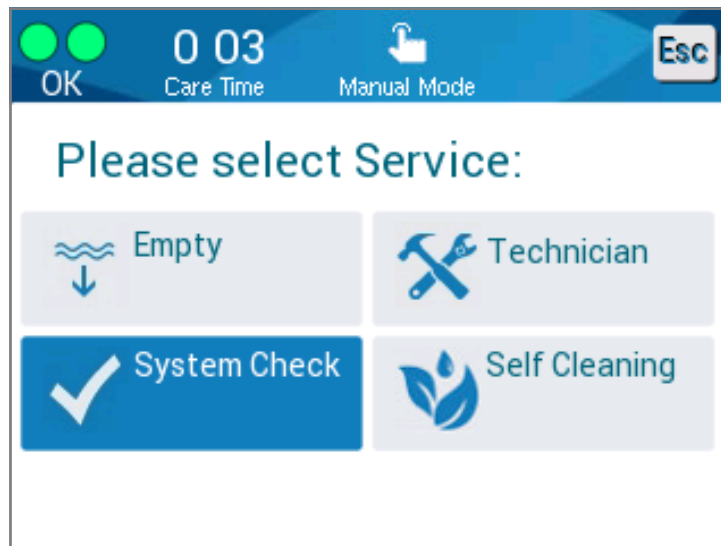

Figure 30: Services Screen

Empty

This function allows for emptying the system of the remaining water, prior to storage of the Allon® system.

To empty the water tank:

1. Switch to Standby Mode (see “Standby”).
2. Disconnect the wrap. Dispose of the wrap.
3. Connect the Special Male Connector to the “Water out” of the connecting water hoses and direct the tube to a bucket or sink for water collection (See image at right).
4. Touch **Empty** on the Services screen. The following screen appears.

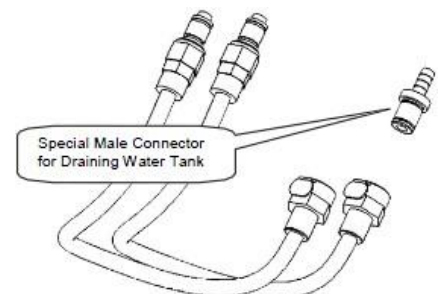

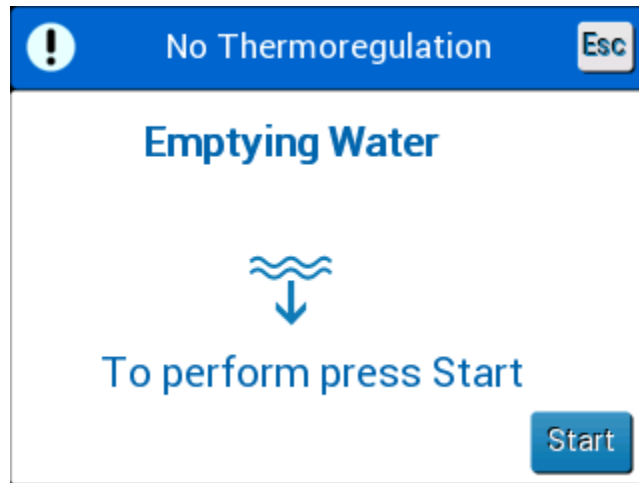
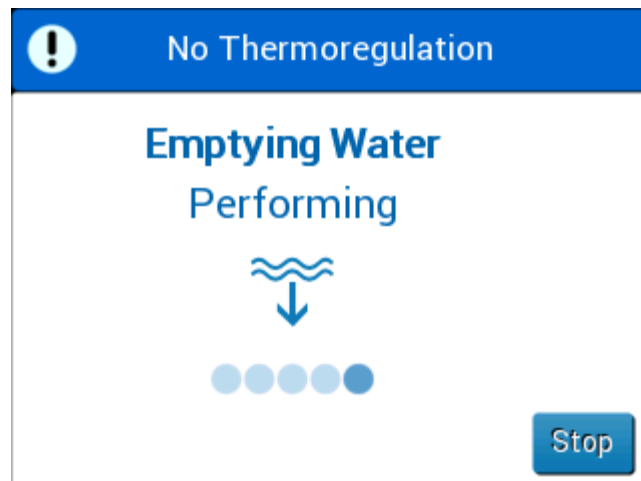

Figure 31: Empty Mode



- When ready for the process to begin, touch Start. Emptying starts and the following screen appears.
- Wait for all the water to drain from the system.

NOTE: If **Stop** is touched, the ESC icon appears  and the action is stopped. Click the icon to continue.

Figure 32: Empty Mode

When emptying is finished the following screen appears.

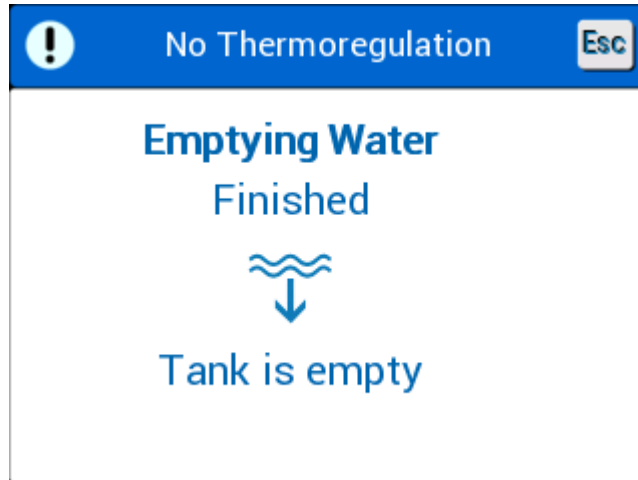



Figure 33: Tank is Empty

To return to the main menu touch the ESC icon . After returning to the main menu, an alarm is activated and “ADD WATER” message appears. The machine is now ready for storage until the next procedure.

NOTE: The recommendations for emptying the water tank depend on the frequency of usage. For frequent usage (3-4 times a week), drain the water at least once a week. For infrequent usage, drain the water after each use.

System Check

A full system check of the system should be done whenever a system problem is suspected. When the machine is turned on, the system performs a self-check to ensure the system safety and performance.

Technician

This is a feature for Belmont Medical Technologies certified technicians only. It is password-protected.

Self Cleaning

This is a feature for Belmont Medical Technologies certified technicians only. It is password-protected.

This feature performs a thermal disinfection of the water tank and internal tubing.

The thermal disinfection of Allon® is an integrated feature, which heats the circulating water of the system, thus allowing the heat to disinfect the internal water pathways of the system, including the water tank.

Thermal disinfection is performed at every Periodic Maintenance.

CAUTION!

- Use only sterile or 0.22 µ filtered water.
- Do NOT use bleach or any other cleaning and disinfectant agent for the internal circulation except sodium dichloroisocyanurate (NaDCC). These agents may harm the system and result in damage to the system.
- Always drain the water after the thermal disinfection process.

NOTE: Self Cleaning is password protected and should only be used by authorized Belmont Medical Technologies personnel.

Thermal Disinfection Process

Required Equipment

- Bypass tube PN #200-00181 or PN #200-00096
- Up to 8 liters of .22 µm filtered or sterile water

To perform Thermal Disinfection:

NOTE: Make sure that water tank is full, and that the bypass tube is connected.

1. In the main menu, select **Services**.
2. Touch **Self Cleaning** and then **OK**.
3. The process is password protected. Insert password.

4. Touch **OK**. A verification message appears.

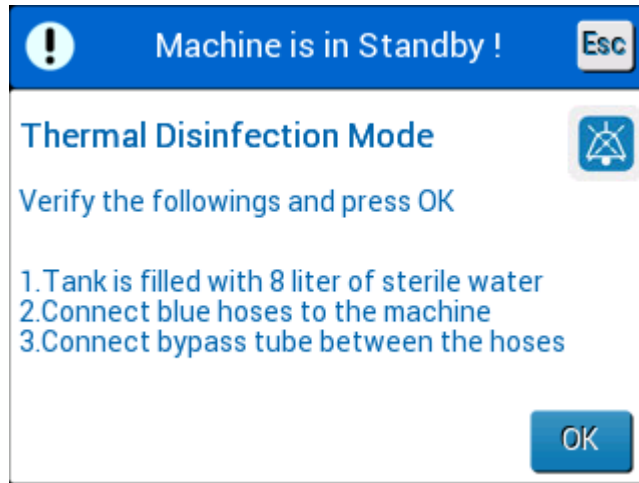

Figure 34: Thermal Disinfection Mode

5. Fill the tank until full, up to 8 liters. Connect the bypass tube and touch **OK**. Self Cleaning begins. Countdown appears on the screen. The process takes about 2 to 3 hours.

CAUTION! Do not touch the machine or hoses during the self cleaning process as they are **HOT**.

NOTE: For more information, refer to the Service manual.

Turning off the System

To turn off the System:

1. Turn off the Allon[®] device by pressing the ON /OFF switch downwards to the OFF position and disconnecting the power cord from the power source.
2. Once the machine is powered off, press the Power Loss Alarm Disable next to the power switch to disable the yellow power loss indicator on the front of the machine. If this button is not pressed, the yellow indicator will flash for approximately 10 minutes before turning off.
3. Close the clamps on the connecting tubes to avoid returning water overflow.
4. Disconnect the connecting tubes from the Allon[®] device and from the ThermoWrap[®].
5. Disconnect the core and surface temperature probes from the Allon[®] device.
6. If the patient is not transferred with the Allon[®] system, proceed to Step 11.
7. Place the temperature probes beside the patient.

8. Upon arrival to the hospital room, reconnect the temperature probes to the Allon[®] device. Reconnect the connecting tubes to the Allon[®] device and the ThermoWrap[®]. Reopen the clamps.
9. Turn on the Allon[®] device to resume treatment.
10. At the end of treatment, repeat steps 1–4.
11. Remove the ThermoWrap[®] and the temperature probes from the patient.
12. Dispose of the ThermoWrap[®] in accordance with hospital guidelines governing non-toxic plastic waste.
13. Disinfect the surface of the connecting tubes and the exterior of the Allon[®] device (see instructions in Chapter 6).
14. Dispose of disposable temperature probes in accordance with hospital procedures for medical waste. Disinfect the reusable temperature probes and/or adaptor cables as required by hospital/clinic protocol. Dispose of any damaged probes as indicated above.
15. After each use or between cases, drop sodium dichloroisocyanurate (NaDCC) tablets or powder into the 6.0 liter water tank and run the device for 30 minutes in Standby Mode.
16. Store the Allon[®] device and its accessories in a safe place.

Chapter 5: Ordering Information

Equipment and Accessories

Every Allon machine is equipped with optional accessory CliniLogger™ (Part # 017-00250) and an Operator's Manual.

All equipment and accessories may be ordered directly from your local Belmont Medical Technologies representative. When ordering parts, specify the model number as listed in this chapter as well as the serial number of your Allon® device.

Available ThermoWraps

ThermoWraps for adult and pediatric models are packed in a twelve-unit packages that contain two six-unit boxes each. The minimum order for any model ThermoWrap is twelve units or any multiplication of twelve.

ThermoWraps for infant models are packed in a twenty four unit packages. The minimum order for any infant model ThermoWrap® is twenty-four units or any multiplication of twenty-four.

Table 5: ThermoWrap® Sizes

	Part Number	Package	Patient Size or Weight	Wrap Length / Width (m)
ThermoWrap® Cardiac	512-03363	12/Box	Fits most patients	1.348/1.319
ThermoWrap® Universal	512-03166	12/Box	168-180cm	1.904/1.321
	512-03160	12/Box	152-168cm	1.934/1.295
	512-03153	12/Box	135-152cm	1.744/1.212
ThermoWrap® Universal (Pediatric)	512-03148	12/Box	122-135cm	1.582/1.193
	512-03141	12/Box	104-122cm	1.398/1.068
	512-03136	12/Box	91-104cm	1.225/0.841
	512-03131	12/Box	79-91cm	1.118/0.739
ThermoWrap® Infant	524-03125	24/Box	7-11 Kg	0.983/0.629
	524-03121	24/Box	4-7 Kg	0.698/0.604
	524-03118	24/Box	2.5-4 Kg	0.660/0.465

Table 6: Allon® Accessory Kits

Sub Part No.	Description	Sub Quantity
200-00400 Adult Accessory Kit with Reusable Temperature Sensors		
014-00020	Reusable Core Temperature Probe, Adult, Gray	1
014-00021	Reusable Surface Temperature Probe, Green	1
200-00109	Connecting Water Tubes, 2 by 2 Way	1
DDT200011	Leaflet for Sensor labels	1
099-00065	Sensors Labels, Multilanguage	1
DDT-063-027	Allon® Step by Step Guide	1
200-00410 Accessory Kit with Adaptor Cables for Disposable Sensors		
014-00028	Adaptor Cable for Disposable Core Temperature Probe, Gray	1
014-00129	Adaptor Cable for Disposable Surface Temperature Probe, RJ, Green	1
200-00109	Connecting Water Tubes, 2 by 2 Way	1
DDT200011	Leaflet for Sensor labels	1
099-00065	Sensors Labels, Multilanguage	1
DDT-063-027	Allon® Step by Step Guide	1
200-00420 Infant Accessory Kit with Reusable Temperature Sensors		
014-00005	Reusable Core Temperature Probe, Infant, Gray	1
014-00021	Reusable Surface Temp. Probe Green	1
200-00109	Connecting Water Tubes, 2 by 2 Way	1
DDT200011	Leaflet for Sensor labels	1
099-00065	Sensors Labels, Multilanguage	1
DDT-063-027	Allon® Step by Step Guide	1

Table 7: Accessories Individual Replacement

Model No.	Description
200-00109	Connecting Water Tubes, 2 by 2 Way
200-R0130	Filter unit (internal)
002-00069	Male Connector for Draining Water Tank
014-00020	Reusable Core Temperature Probe, Adult, Gray
014-00005	Reusable Core Temperature Probe, Infant, Gray
014-00021	Reusable Surface Temperature Probe, Green
014-00035	Disposable Core Temperature Probe, 9 Fr, Smiths Medical ER400-9 (20/pack)
014-00036	Disposable Core Temperature Probe, 7 Fr, Metko FMT400/AOR-D2 (20/pack)
014-00038	Disposable Core Temperature Probe, 9 Fr, TE Measurement Specialties 4491 (20/pack), WHILE SUPPLIES LAST
014-00220	Disposable Core Temperature Probe, 9 Fr, DeRoyal 81-020409 (10/pack), USA ONLY
014-00321	Disposable Surface Temperature Probe, RJ (20/pack)
014-00028	Adaptor Cable for Disposable Core Temperature Probe, Gray
014-00129	Adaptor Cable for Disposable Surface Temperature Probe, RJ, Green
017-00250	CliniLogger™ assembly (Optional)
200-01200	Temperature Splitter Kit (Optional)

Chapter 6: Maintenance

Introduction

This chapter outlines the maintenance instructions for the Allon® system. Qualified hospital staff may perform routine maintenance unless otherwise specified.

CAUTION!! The repair and servicing of the Allon® system should be performed only by Belmont Medical Technologies or authorized agents of Belmont Medical Technologies.

Service Information

When communicating with authorized Belmont Medical Technologies representatives regarding the Allon® system, always state the model and serial numbers on the identification label located on the rear panel of the Allon® device.

When communicating regarding Wraps, refer to the label on the Wrap package for lot number details.

Routine Maintenance

The Allon® device should be periodically inspected and maintained to make sure that it remains in optimum condition.

NOTE: Annual checks should be performed every 12 months as described in the service manual and reusable probes should be replaced as required per the labelling.

A recommended routine inspection and maintenance schedule is provided in Table 8.

Table 8: Inspection and Maintenance Schedule

Frequency	Inspection/Service	Performed By
Before each treatment	<ul style="list-style-type: none"> • Clean connecting tubes and Quick Coupling Connectors with a wet cloth. • Perform a visual inspection for any mechanical failure in sensors, connecting tubes, and power cable. • Perform a visual inspection of the exterior of the Allon® Device. • Circulate NaDCC per manufacturer's instructions through Allon® Device for 30 minutes. 	Staff
As required by hospital/clinic protocol	<ul style="list-style-type: none"> • Routine external cleaning and disinfecting. • Empty Allon: <ul style="list-style-type: none"> – For Frequent Use (3-4 times a week): drain once a week – For Infrequent Use: drain after each use • Replace Connecting Water Hoses (PN #200-00109) periodically 	Staff
Annually	<ul style="list-style-type: none"> • Thermal disinfection • Replace filter * • Preventive maintenance 	Belmont Medical Technologies' authorized technician

Cleaning and Disinfection

The cleaning and disinfecting of the Allon® includes both external and internal cleaning and disinfection.

NOTE: All instructions regarding the reusable temperature probes are not relevant for US market or other select markets.

Routine Maintenance

Cleaning and disinfection of the external surface and the water reservoir of the system should be done before each use of the device. The system components may be contaminated during use and storage of the device from numerous factors, for example: soiled hands of the user, airborne pathogens, accidental events.

NOTE: Follow your hospital protocols for disinfecting the product. Make sure to follow the manufacturer's instruction for the disinfectants.

CAUTION!

- Do not use any kind of brush on the machine and its accessories.
- Do not rinse the machine with water.
- Do not wash the electrical power socket.
- Do not use any saline or irrigated fluids.
- Do not use any aggressive compound, such as NaOH, H₂O₂.
- Do not use any organic or ester solvents.
- Always check the temperature probes for scratches, frayed wires, tears before and after cleaning. If the probe is damaged, **do NOT use it.**

Required Tools for Cleaning and Disinfection

- PPE (Personal Protective Equipment) according to the disinfectant manufacturer's instructions
- Lint Free Cloths
- Recommended disinfectant (see “Recommended Disinfectants for External Surfaces” and “Recommended materials for Water Purification”)
- Sterile water - At least 6 liters

Recommended Disinfectants for External Surfaces

- Clorox® Healthcare Bleach Germicidal Cleaner (EPA registration number 56392-7)
- Chlorinated bleach solution (5.25% sodium hypochlorite concentration)
- Quaternary ammonium compounds (ammonium chloride as active ingredient)

Recommended Materials for Water Purification

- Sodium dichloroisocyanurate (NaDCC)

Before Each Use

1. Use PPE as recommended by the disinfectant's manufacture.
2. Make sure that the system is turned off and unplugged from power.
3. Using a lint free cloth with sterile water, clean the exterior of the machine, the LCD screen, the hoses, the power cord and the reusable temperature probes¹ from any soiling.
4. Prepare the disinfectant solution as described by the manufacturer.
5. Using a lint free cloth with the disinfectant, disinfect the exterior of the machine, the LCD screen, the hoses, the reusable temperature probes¹ and the power cord.

NOTE: Allow disinfectant contact time according to the disinfectant manufacturer's instructions.

6. For residue removal, use a new lint free cloth moistened with sterile water. Use the cloth on the exterior of the system, the LCD screen, the power cord, the reusable temperature probes¹ and the hoses.

CAUTION! Do not apply physical pressure on the screen.

7. Prior to treating the patient:
 Fill the water tank with 6 liters sterile water.
 Plug the system into power, turn ON and start the system.
8. Continue patient's treatment according to the protocol.

For storage - Refer to "Before Storage".

Before Storage

NOTE: See "Required Tools for Cleaning and Disinfection" and "Recommended Disinfectants for External Surfaces".

1. Add sodium dichloroisocyanurate (NaDCC) tabs or powder to the water tank per NaDCC manufacturer instructions.
2. Operate the machine on Standby mode for 30 minutes.
3. Drain the water using the Male Connector for Draining Water Tank.

NOTE: The emptying process is an integrated feature of the Allon®.

Refer to the Emptying instruction: "Empty".

4. Turn off the system and turn off the LED by pressing the Power Loss Alarm Disable button.
5. Unplug the power cord from wall outlet.
6. Using a lint free cloth with sterile water, clean the exterior of the machine, the LCD screen, the hoses, the power cord and the reusable temperature probes¹ from any soiling.
7. Prepare the disinfectant solution as described by the manufacturer.
8. Using a lint free cloth with the disinfectant, disinfect the exterior of the machine, the LCD screen, the hoses, the power cord and the reusable temperature probes¹.

NOTE: Allow disinfectant contact time according to the disinfectant manufacturer's instructions.

9. For residue removal, use a new lint free cloth moistened with sterile water. Use the cloth on the exterior of the machine, the LCD screen, the power cord, the hoses and the reusable temperature probes¹.

CAUTION! *Do not apply physical pressure on the screen.*

10. Store the machine in a cool and dry place.

1.Reusable probes - Not applicable for US market or other select markets

Thermal Disinfection

The Thermal Disinfection of the Allon® is an integrated feature, which heats the circulating water of the system, thus allowing the heat to disinfect the water tank from contamination.

The Thermal Disinfection is performed for every new manufactured system and at every Periodic Maintenance (see Chapter 4).

Cleaning, Disinfecting and Sterilization of the Reusable Temperature Probes

NOTE: All instructions regarding the reusable temperature probes are NOT applicable for the USA market or other select markets.

NOTE: The cleaning, disinfecting and sterilization of the reusable temperature probes are according to the manufacturer's instruction.

WARNING: Disposable probes are not to be reused. Improper use can lead to cross contamination and deterioration of safety.

1. When using disposable temperature probes - dispose of the temperature probes.
2. When using reusable temperature probes - they should be cleaned and disinfected/sterilized:
 - **Cleaning:** Clean with a mild detergent and water.
 - **Disinfection:** Disinfect with alcohol 70% or activated dialdehyde, then thoroughly rinse with water.
 - **Sterilization:** Sterilize with ethylene oxide. After sterilization, the probes must be ventilated with aeration time of minimum 12 hours.

CAUTION! Do not use the steam autoclave method to sterilize the reusable temperature probes and the reusable adapters.

Filter Replacement

The filter is for filtering hard soils or large particles and it is not intended for filtering the water from bacterial contamination.

The filter must be replaced every twelve months.

NOTE: The filter should be replaced only by Belmont Medical Technologies authorized personnel / authorized biomedical personnel. See the Service Manual for replacement instructions.

NOTE: Filter replacement could be performed by Belmont Medical Technologies / biomedical authorized personnel if needed more frequently than once a year (according to water quality).

Annual checks should be performed every 12 months, as described in the Service Manual.

System Check Service

The System Check service is initiated from the Services menu.

The System Check service performs a complete check of the system by checking the functionality of the following components:

- Screen and Buzzer
- Pump
- Wrap Connection
- Pressure Meter
- Heating and Cooling Unit
- Temperature of Water Inflow and Water Outflow

Successful completion of the system check service indicates that the Allon® device is operational.

NOTE: If the Allon® was out of use for a long time, performing a full System Check is recommended.

To perform system check:

NOTE: Before performing System Check, verify that the water tank is full.

1. In the Main menu, select **Services**. The following window appears.

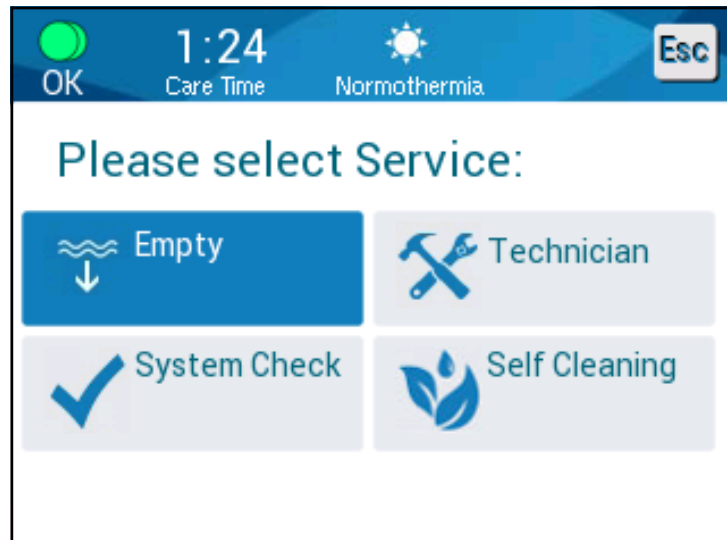

Figure 35: Selecting System Check

2. In the Services screen, select System Check then click OK to confirm. A message appears requesting you to confirm start of System Check.

3. Touch Start.

System Check is initiated. The bar that appears on the screen indicates the progress. System Check takes about 10 minutes. When the process is complete, a message appears on the screen "SYSTEM CHECK COMPLETED".

4. Switch to the Operation screen.

5. Turn Allon® OFF. Switch off the Power Loss Alarm Disable if desired.

Figure 36: System Check in Progress

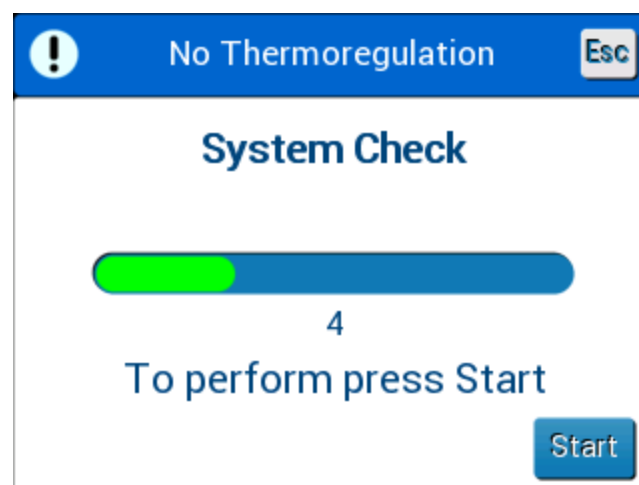

Chapter 7: Troubleshooting

General

The Allon[®] device is equipped with self-testing routines that continuously monitor system operation. If a system fault or malfunction is detected, a fault message appears on the message display. Should a malfunction occur, consult the Troubleshooting Guide in Table 9, Table 10, and Table 11.

Troubleshooting Guide

Table 9 lists some possible scenarios that do not appear on the message display, their potential cause, and recommended actions.

Table 10 lists water tank overfilling troubleshooting.

Table 11 provides a list of fault messages that appear on the Allon[®] device screen.

WARNING!!! The repair and servicing of the Allon® system should be performed only by Belmont Medical Technologies or authorized agents of Belmont Medical Technologies.

Table 9: Allon® System (No Message) Troubleshooting Guide

Observation	Possible Problem	Action to be Taken
The power switch of the Allon® device is set to "ON" but it is not activated and the control panel is blank.	Allon® device is unplugged.	Check the 115/230 VAC power cable connections.
	No line voltage	Call the biomedical technician.
ThermoWrap® begins to leak.	The ThermoWrap® was accidentally punctured during the course of the operation.	Turn off the Allon® device and allow the water to return to the reservoir. Replace the ThermoWrap® if possible
Water leaks from the connector between ThermoWrap® and the connecting tube.	Connecting tubes are not connected properly.	Close clamps on ThermoWrap®. Disconnect connecting tubes and re-connect connecting tubes until the click sound is heard.
	Damage to connecting tubes.	Replace connecting tubes.
	Damage to Quick Coupling Connector.	Call the biomedical technician.
Water leaks between connecting tubes and the Allon® device.	Connecting tubes are not connected properly.	Disconnect connecting tubes from the machine and reconnect again.
	Damage to connecting tubes.	Replace connecting tubes.
	Damage to Quick coupling connector.	Call the biomedical technician.

Table 10: Water Tank Overfilled- Draining the Water Tank

Observation	Action to be taken
Water tank overfilled.	<p>If it is necessary to drain the water tank because of overfilling, proceed as follows:</p> <ol style="list-style-type: none"> 1. Connect connecting tube to the right Quick Coupling Connector (under the Core Sensor socket). The ThermoWrap® cannot be connected when emptying. 2. Connect the special male connector to the connecting tube. (See Figure 37) 3. Turn ON the Allon® device 4. Select Empty mode in Services and click Start. 5. Allow the excess water to drain into a receptacle, pail or sink. 6. When the desired water level has been reached, turn OFF the Allon® device. <div data-bbox="539 953 1098 1339" style="text-align: center;"> <p>The diagram illustrates the components for draining the water tank. It shows two sets of connecting tubes. The top set consists of two tubes with quick-coupling connectors. The bottom set consists of two tubes with similar connectors. A separate, small, cylindrical 'Special Male Connector for Draining Water Tank' is shown to the right. A callout box with a pointer identifies this connector.</p> </div> <p>Figure 37: ThermoWrap® Connecting Tubes and Special Male Connector</p>

Table 11: Allon® System Messages Troubleshooting Guide

Message	Cause of Problem	Action to be taken	Comments
<p>Add Water</p> 	Water level is too low	Refill water tank to maximum	The alarm can be muted for 10 minutes.
<p>Connect Water Tubes</p> 	Connecting tubes are not connected.	<p>Connect connecting tubes. Check for snarls, folds, or objects that obstruct the water flow in the wrap.</p> <p>Check clamps.</p>	The alarm can be muted for 10 minutes.
<p>Connect Core Sensor</p> 	No core temperature probe is inserted in its socket - at power up	Connect core temperature probe	After power up, this alarm is muted automatically for 10 minutes.
	No core temperature probe is inserted in its socket - after power up		If the Core temperature probe is not connected during an operation, the alarm can be muted for 10 minutes.

Table 11: Allon® System Messages Troubleshooting Guide (Con't)

Message	Cause of Problem	Action to be taken	Comments
<p>Connect Surface Sensor</p> 	<p>No surface temperature probe is inserted in its socket.</p>	<p>Connect surface temperature probe.</p>	<p>No audible alarm.</p>
<p>Check Water Tubes</p> 	<p>Wrap is blocked due to improper wrapping.</p> <p>Wrap clamps are closed.</p>	<p>Check for snarls, folds, or objects that obstruct the water flow in the wrap.</p> <p>Check clamps.</p>	<p>The alarm can be muted for 10 minutes.</p>
<p>Check Core Sensor</p> 	<p>Misplacement of core temperature probe in core socket.</p> <p>Core temperature probe's adapter is connected to the Allon® device without the temperature probe.</p>	<p>Connect the core temperature probe to the appropriate socket.</p> <p>Connect disposable temperature probe.</p>	<p>If the Core temperature probe was incorrectly connected at power-up, there will be no alarm, only a message for 60 minutes.</p> <p>If the Core temperature probe was incorrectly connected during an operation, the alarm can be muted for 10 minutes.</p>

Table 11: Allon® System Messages Troubleshooting Guide (Con't)

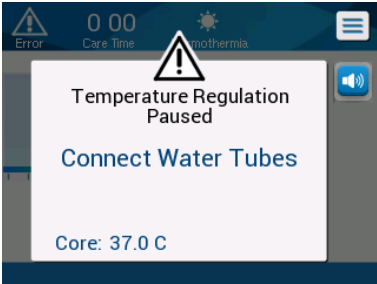
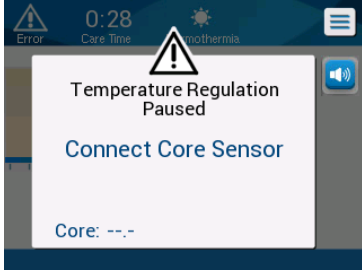

Message	Cause of Problem	Action to be taken	Comments
<p>Check Surface Sensor</p> 	<p>Misplacement of surface temperature probe in socket</p> <p>Surface temperature probe's adapter is connected to the Allon® without the temperature probe</p>	<p>Connect the surface temperature probe to the appropriate socket.</p> <p>Connect disposable temperature probe.</p>	<p>If the Surface temperature probe was incorrectly connected at power up with the Core temperature probe not connected, there will be an alarm that can be muted for 10 minutes.</p> <p>If the Surface temperature probe was incorrectly connected during operation, the alarm can be muted for 10 minutes.</p>
<p>Low Core Temperature</p> 	<p>This message appears when Set Point Temperature is <36°C and Core Temperature is <32°C or when the Core Temperature is <28°C</p>	<p>The operator needs to confirm the location of the core temperature probe and touch OK to continue.</p>	<p>When Core temperature is below 32°C: The alarm can be muted for 10 minutes.</p> <p>When Core temperature is below 28°C: The alarm can be muted for 10 minutes.</p>
<p>Water temp. too low</p> 	<p>When the water temperature in the system is less than 10°C (50°F)</p>	<p>Thermoregulation stops. Turn OFF the system for 3 seconds and then turn it ON again. If the problem persists, turn OFF the Allon® and contact your local service representative.</p>	<p>The alarm can be muted for 10 minutes.</p>

Table 11: Allon® System Messages Troubleshooting Guide (Con't)

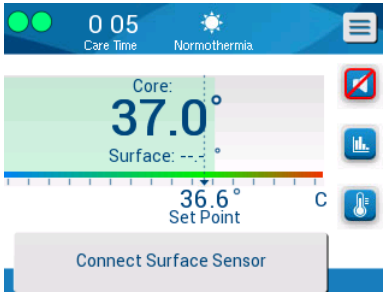
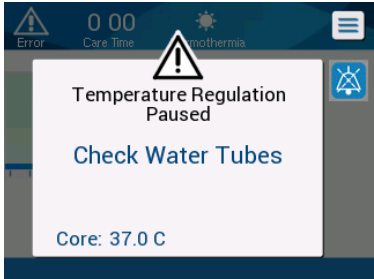
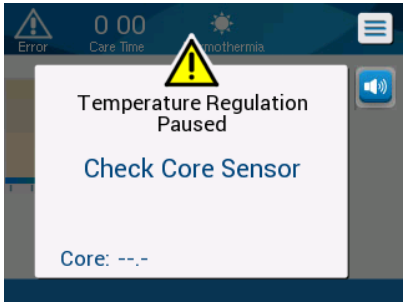
Message	Cause of Problem	Action to be taken	Comments
<p>Water temp. too High</p> 	<p>The alarm for High Water Temperature can be configured in "Settings". The alarm and message are activated according to the selected alarm limit.</p> <p>The available values range from 36-42° in increments of 0.5°C: 37°C, 38°C, 39°C, 40°C, 41°C, and 42°C.</p>	<p>Thermoregulation stops until the water cools or the system halts.</p> <p>Turn OFF the system for 3 seconds and then turn it ON again. If the problem persists, turn OFF the Allon® and contact your local service representative.</p>	<p>The alarm can be muted for 10 minutes.</p>
<p>Patient's temperature is above XX.X°C</p> 	<p>The alarm for High patient's temperature can be configured in "Settings". The alarm and message are activated according to the selected alarm limit.</p> <p>The available values range from 38-41° in increments of 0.5°C: 38°C, 38.5°C, 39°C, 39.5°C, 40°C, 40.5°C, and 41°C.</p>	<p>Check that the Core Temperature Probe is in place and follow the patient's temperature.</p> <p>Inform the physician.</p>	<p>Thermoregulation continues.</p> <p>The alarm can be muted for 10 minutes.</p>
<p>Patient's temperature is below XX.X°C</p> 	<p>The alarm for Low Patient Temperature can be configured in "Settings". The alarm and message are activated according to the selected alarm limit.</p> <p>The available values range from 30-35° in increments of 0.5°C: 30°C, 30.5°C, 31°C, 31.5°C, 32°C, 32.5°C, 33°C, 33.5°C, 34 °C, 34.5°C, and 35 °C.</p>	<p>Check that the Core temperature probe is in place and follow the patient's temperature.</p> <p>Inform the physician.</p>	<p>Thermoregulation continues.</p> <p>The alarm can be muted for 10 minutes.</p>

Table 11: Allon® System Messages Troubleshooting Guide (Con't)

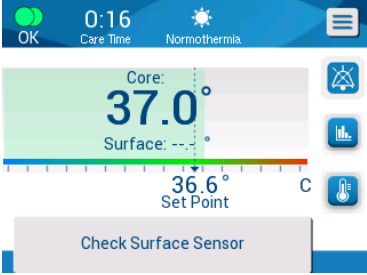
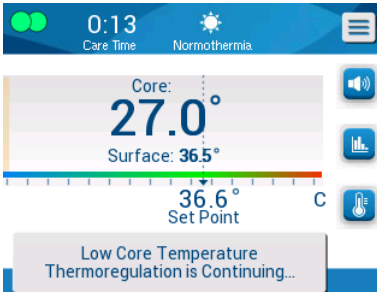
Message	Cause of Problem	Action to be taken	Comments
<p>Out of Normothermia Range</p> 	<p>This appears when the operator chooses Set Point temperature for Normothermia Mode <36°C or >38.0°C.</p>	<p>Touching the OK button confirms the new Set Point Temperature and eliminates the message.</p>	<p>No alarm</p> <p>Thermoregulation continues.</p>

Chapter 8: Messages And Alarms

If the wrap's tubes are connected, the temperature probes are connected correctly, and core temperature is measured, water circulation will continue without additional user action. If any of the above conditions is not fulfilled, the operation panel message area displays technical and/or clinical alarm messages with a sign.

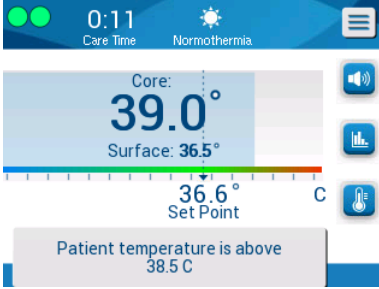
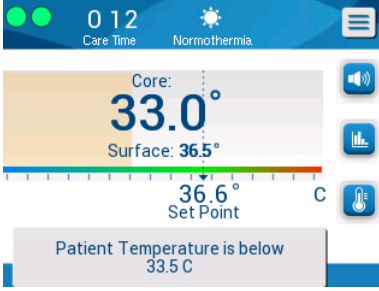
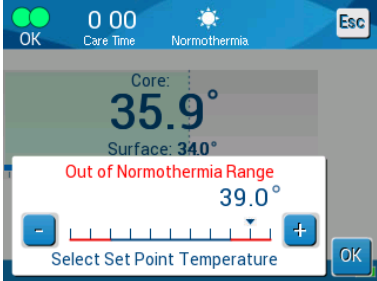
NOTE: Clinical Alarms represent Medium Priority Alarms.

NOTE: Sound Pressure of the Alarms is 67.5 dBA at a distance of 10 centimeters.

Technical Messages and Alarms

The following technical messages might appear:

Table 12: Technical Messages and Alarms

Message	Message window
Add Water	
Connect Water Tubes	

Table 13: Technical Messages and Alarms (Con't)

Message	Message window
Connect Core Sensor	
Check Water Tubes	
Check Core Sensor	
Check Surface Sensor	

Follow the instruction of the technical messages to solve the problem.
For example, add water if necessary, or connect temperature probes if not connected.

Clinical Messages and Alarms

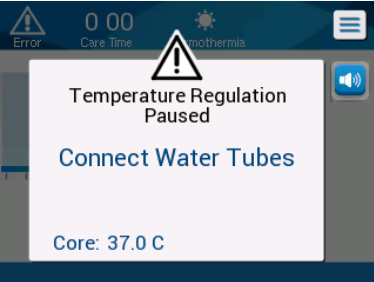
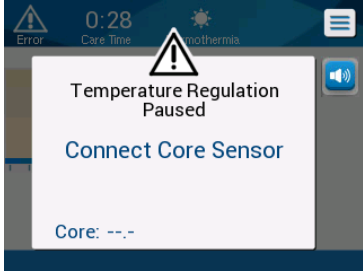
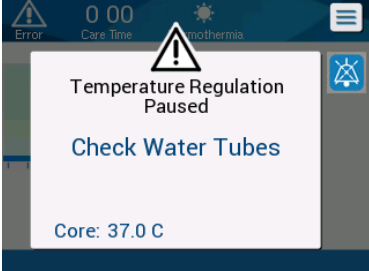
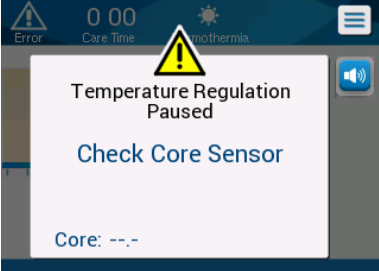
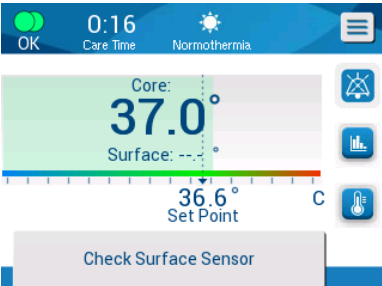
Clinical messages call for the attention of the operator (doctor or nurse) to the condition of the patient or call for user confirmation of the setting by touching the OK key.

Clinical messages include the following:

Table 13: Clinical Messages and Alarms

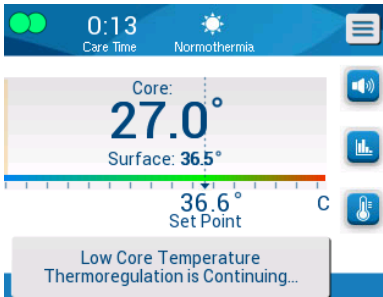
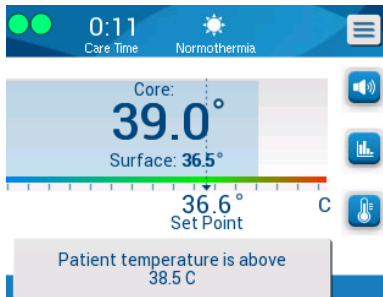
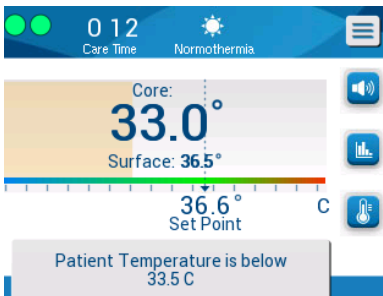
Message	Message in window	Description
Low Core temperature		<p>The operator needs to confirm the location of the core temperature probe and touch OK to continue.</p> <p>The alarm can be muted for 10 minutes.</p>
Patient's temperature is above XX.X°C		<p>The alarm and message are activated according to the selected alarm limit.</p> <p>Thermoregulation continues.</p> <p>The alarm can be muted for 10 minutes.</p>
Patient's Temperature is below XX.X°C		<p>The alarm and message are activated according to the selected alarm limit.</p> <p>Thermoregulation continues.</p> <p>The alarm can be muted for 10 minutes.</p>

NOTE: It is possible to change the range of these alarms in the Settings screen. The user can choose at which temp the "High Patient Temp" and "Low Patient Temp" alarms will be activated.

Safety Messages and Alarms

NOTE: Thermoregulation stops during Safety Messages.

Safety messages indicate to the users that the system has either overcooled or overheated the circulating water.

Safety messages include:



- **WATER TEMPERATURE TOO LOW**



- **WATER TEMPERATURE TOO HIGH**

If such a condition occurs, the user should consider shutting down the system and finding the cause of the problem.

Informative Messages

Informative messages indicate the status of the machine.

These messages are for information only and do not require any user action.

The message appears at the bottom of the Main Screen.

Informative messages include:

- **Out of Normothermia Range:**

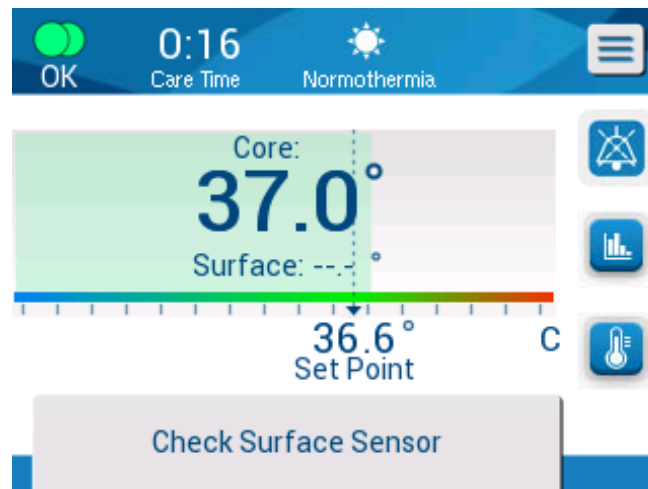
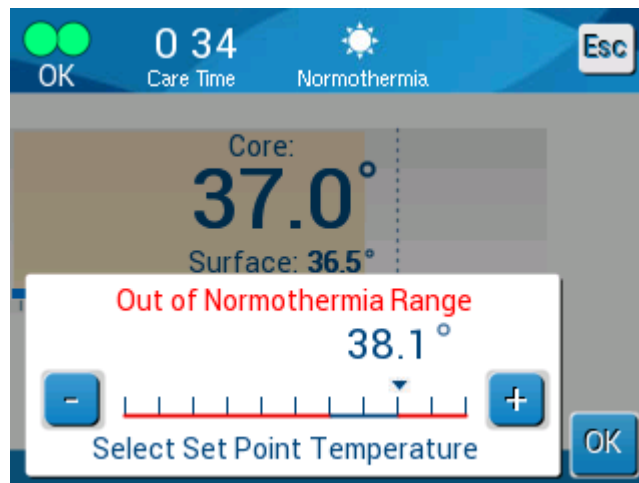

- **Connect Surface Sensor:**

Constant alarms occur in the following states:

- Halt condition
- Select Mode screen

The following messages should be checked and confirmed:

- Low Core temperature thermoregulation is continuing...
- Out of Normothermia Range
- Patient Temperature above XX.X°C (*)
- Patient Temperature below YY.Y°C (*)
- Water Temp Too High (*)

NOTE: Only authorized users can change the range of the alarms marked by (*) in the Settings screen. The user needs to insert a password to enter the Settings panel and change the alarm limit.

Loss of Power Indicator

In the event that the machine loses power or is unplugged during operation, a yellow indicator on the front panel will flash.

This indicator will continue to flash for 10 minutes until power is restored or the Power Loss Alarm Disable button on the back of the unit is pressed.

Alarm Delay

The following conditions generate an alarm only after a period of 30 seconds of being out of alarm limits:

- Patient temperature is below XX.X°C:
Patient core temp is below the pre-configured alarm limit in the Settings menu.
- Patient temperature is above XX.X°C:
Patient core temp is above the pre-configured alarm limit in the Settings menu.
- Water temp too high:
Water temp is above the pre-configured alarm limit in the Settings menu.

NOTE: The limits are subject to change according to user settings.

Entering the limits range disables the alarms immediately. A new alarm is generated again after an additional 30 seconds after the out of the limit value is measured.

Chapter 9: Optional Clinilogger™

Installation And Operating Instructions

Overview and Installation

Introduction

The purpose of the CliniLogger™ device is to save the Allon® / CritiCool® systems' vital data for further reference. By means of the CliniLogger™ Viewer software, the user can use an external PC to review this saved data.

Using the CliniLogger™ Application

The CliniLogger™ device connects to the RS-232 (serial) connector in the rear of the Allon® for data transfer. While the device is connected, **data is saved at one-minute intervals.**

Connect the CliniLogger™ device to the Allon before the start of the medical procedure.

Belmont Medical Technologies recommends recording Allon® device data for one patient at a time. At the end of the procedure, disconnect the CliniLogger™ device from the thermoregulation machine and connect to a PC. Download the data from the device and then reconnect the CliniLogger™ to the Thermoregulation machine so it is ready for the next procedure.

The CliniLogger™ Software

The CliniLogger™ device is supplied with a CliniLogger™ Viewer software CD to be installed on a PC for downloading and viewing the saved data from the Allon.

Installing the Software

To install the CliniLogger™ software:

1. On your PC, double-click on **My Computer** and open the CD drive.
2. Double-click the **Installer** folder.
3. Double-click the **Volume** folder.
4. Double-click **setup**; the CliniLogger™ install window appears.

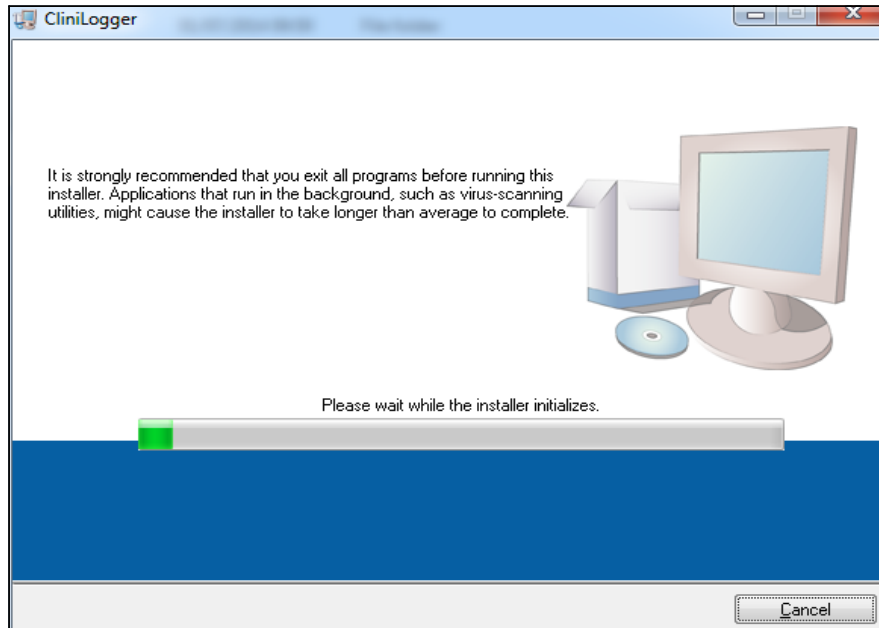

Figure 38: CliniLogger™ Initialization

When initialization finishes the following screen appears.

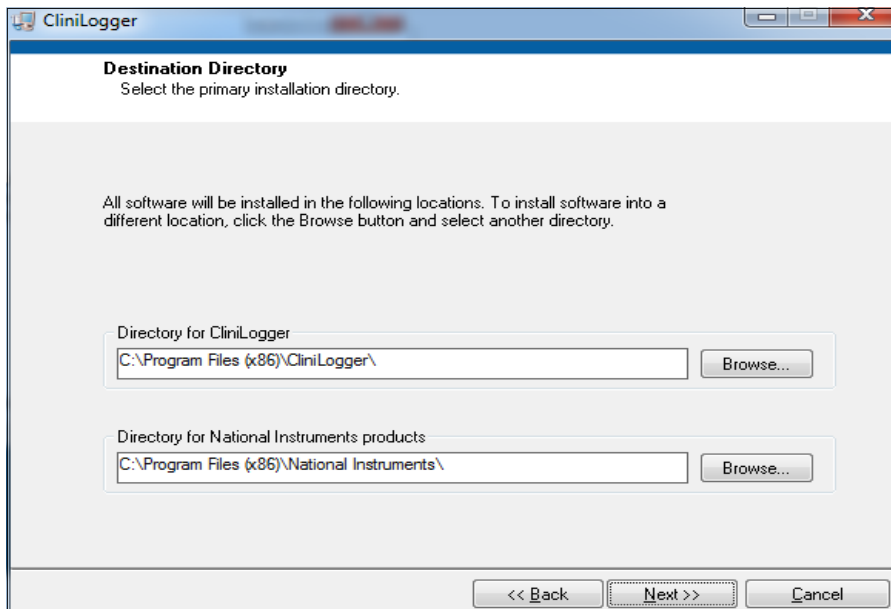

Figure 39: CliniLogger™ Installation

5. You can change the installation location by clicking **Browse** and selecting a new location. Click **Next**. The License Agreement window appears.

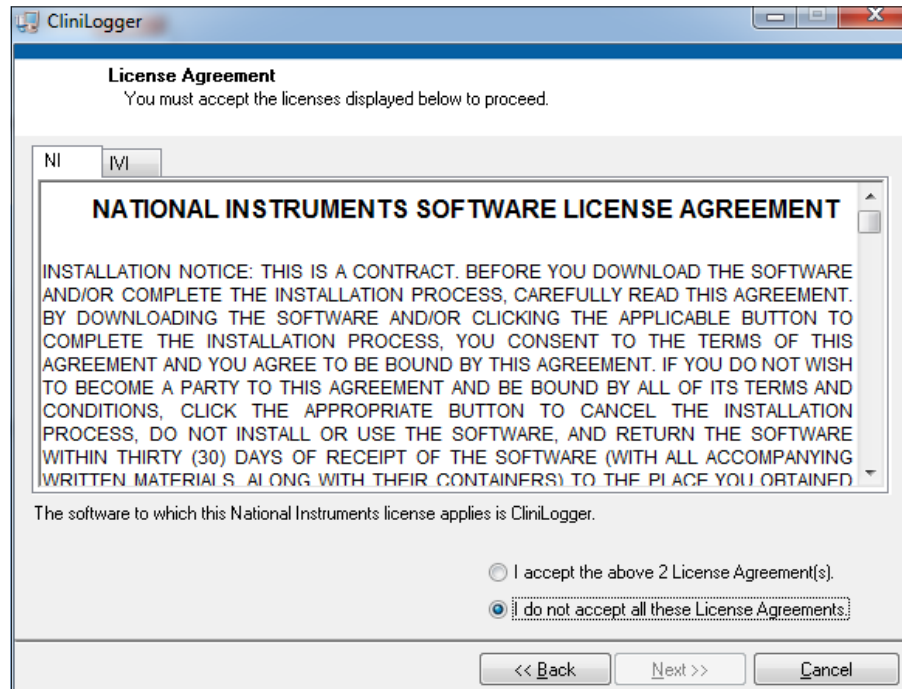

Figure 40: CliniLogger™ Agreement

6. Select **I accept the above 2 License Agreement(s)** to accept the license agreements and click **Next**. The Start Installation window appears.

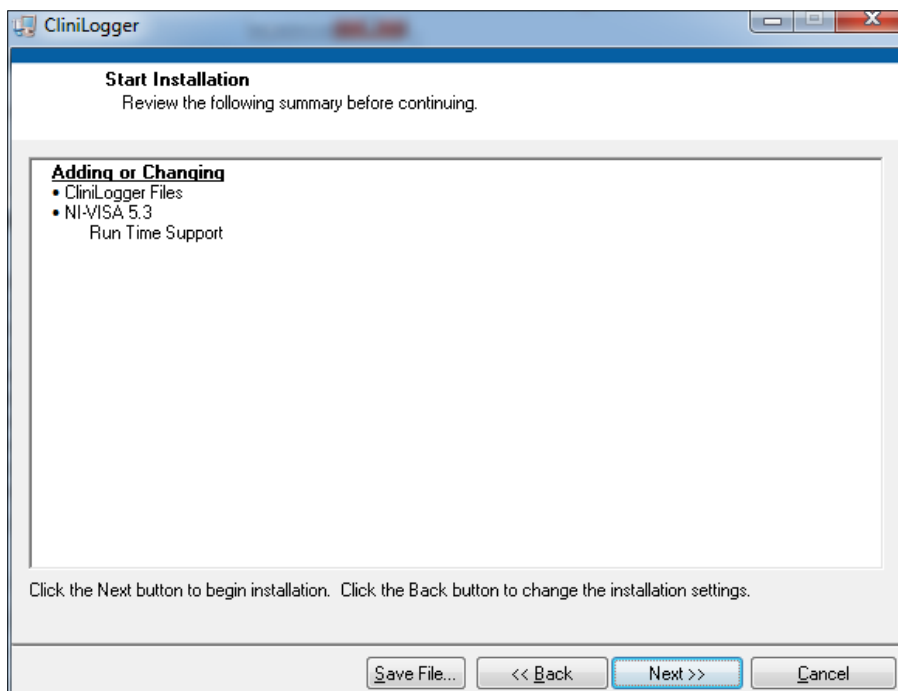

Figure 41: Start Installation

7. Click **Next**; you can follow the installation progress in the progress bars until it finishes.

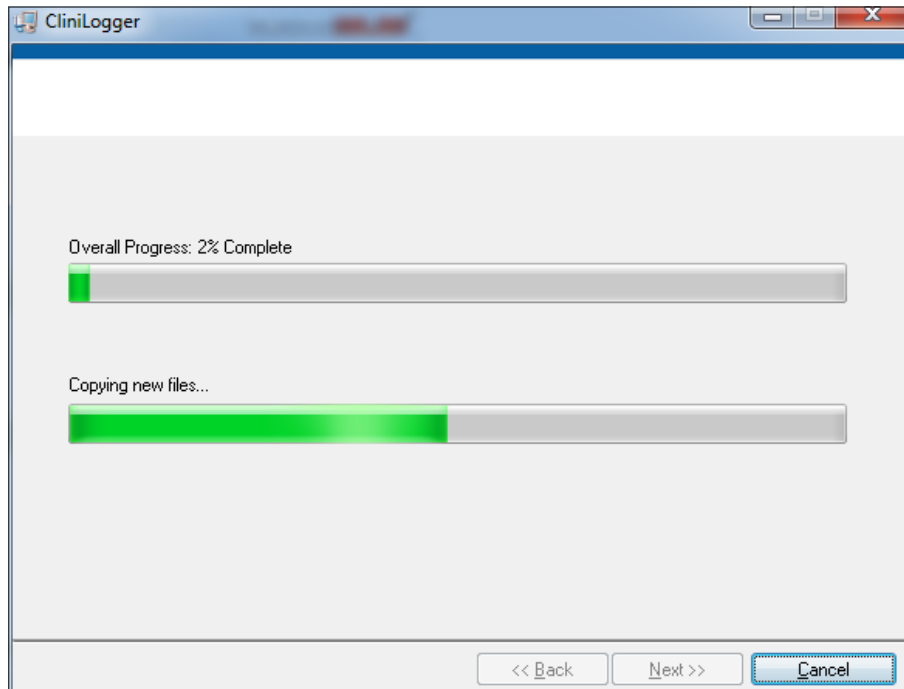

Figure 42: Installation Progress

When the installation is finished, the **Installation Complete** window appears.

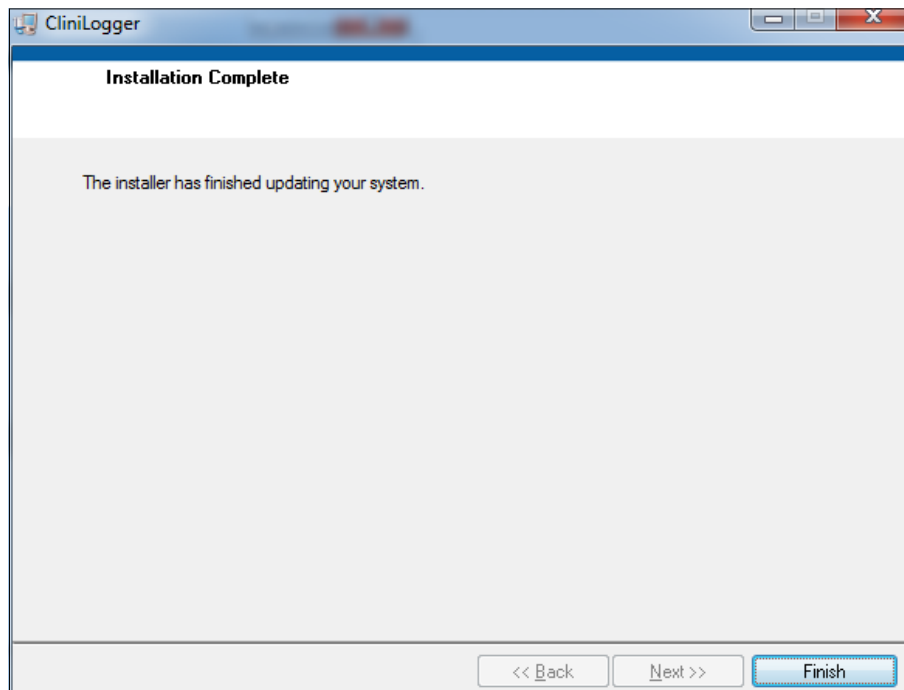

Figure 43: Installation Complete

8. Click **Finish** to complete and exit the software installation.
9. Copy "User Ver 1.5" folder from CD to your desktop.

10. You can now open "User Ver 1.5" folder and click the Clinilogger™.exe file to start the application.

Using the Clinilogger™ Viewer Application

Downloading Data

You can download data from the Clinilogger™ Device to the Clinilogger™ Viewer Application on the PC.

To start the Clinilogger™ application:

1. From the Windows **Start** menu, click **Programs** > **Clinilogger™**.
2. Click on the **Clinilogger™** icon; the Clinilogger™ window appears.

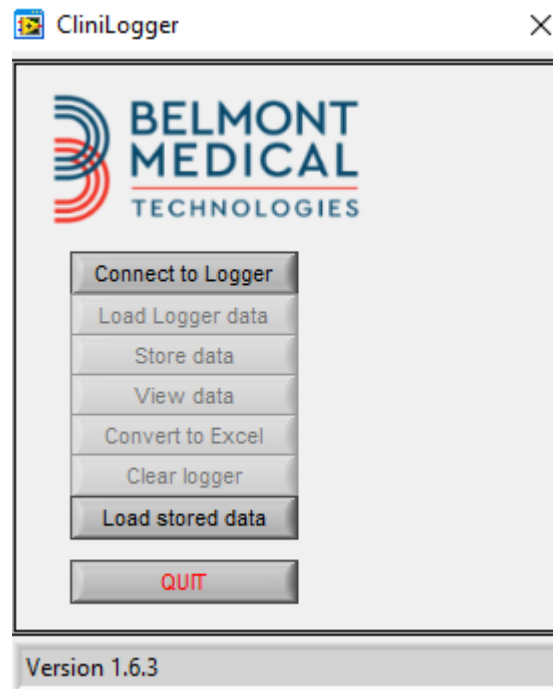

Figure 44: Clinilogger™ Application Window

3. Connect the Clinilogger™ device to the serial COM1 port of the PC.

NOTE: Verify that the Clinilogger™ device is connected to the COM 1 –10 port or you can use with USB to RS232 adaptor.

4. Click **Connect to Logger**, the software traces the COM port where the Clinilogger™ is connected – wait for the

Connected message.

5. Click **Load Logger data**, wait for the **Complete** message.
6. Click **Store data**, and choose a file and a location.
7. Click **View data**; the graph opens.
8. You can also click **Convert to Excel** to present the data in Excel format.
9. Click **Clear logger** after saving the data to prepare the device for the next use.

NOTE: You should erase the data on the CliniLogger™ manually after each patient, otherwise, the CliniLogger™ continues to burn data from the last patient.

Viewing Downloaded Data

1. To view downloaded data:
 1. Double-click the CliniLogger™ Viewer icon. The CliniLogger™ window appears.

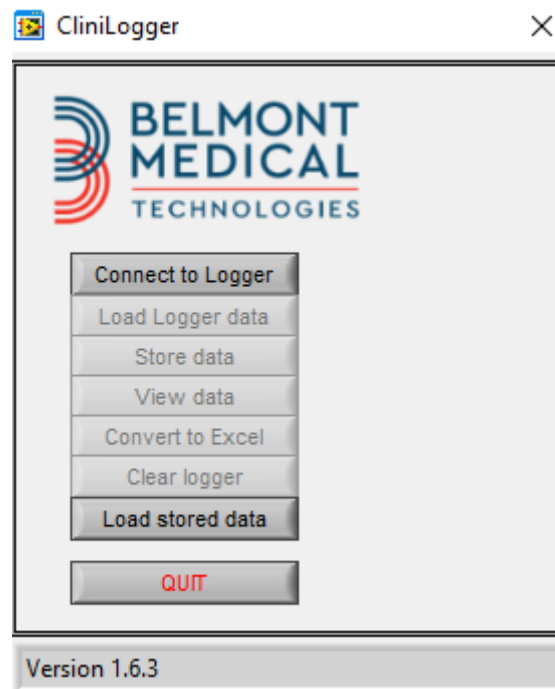

Figure 45: CliniLogger™ Window

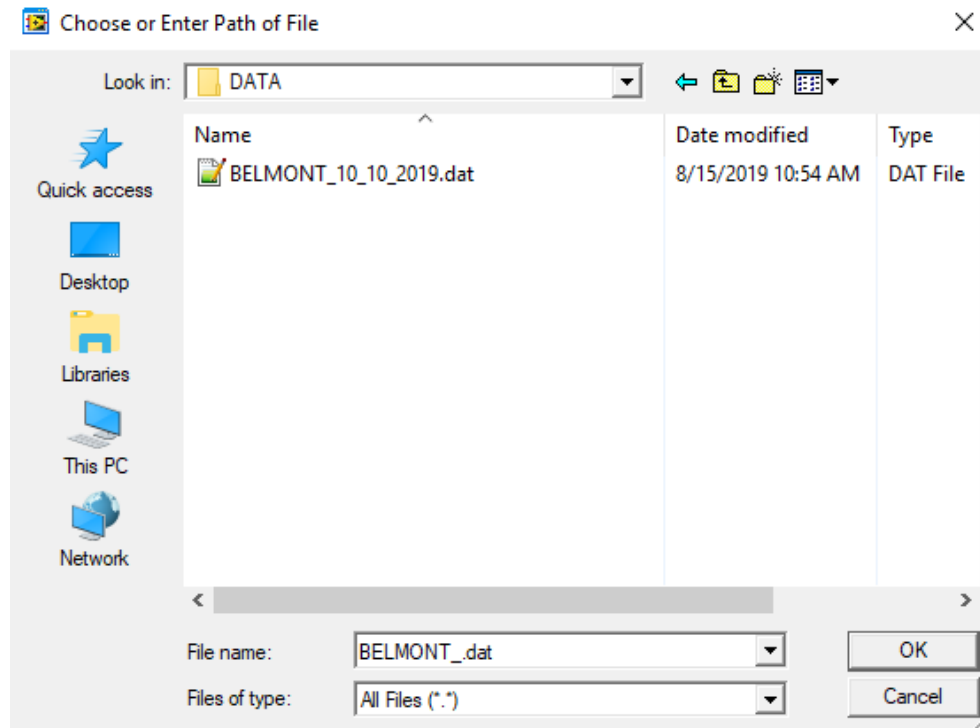
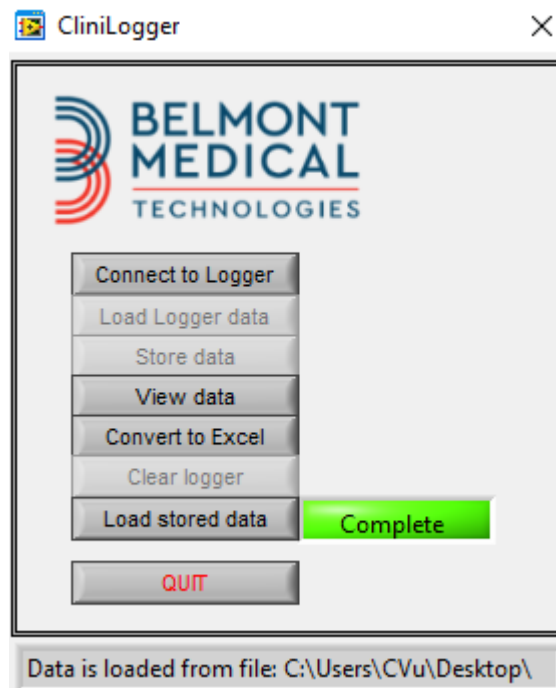

Figure 46: CliniLogger™ Window

2. Click **Load stored data** and choose the file you would like to view.



When the data has been loaded the **Complete** message appears

Figure 47: “Complete” Message

Click **View data** - the graph opens.

3. To convert to Excel, click **Convert to Excel**.

CliniLogger™ Viewing Panel

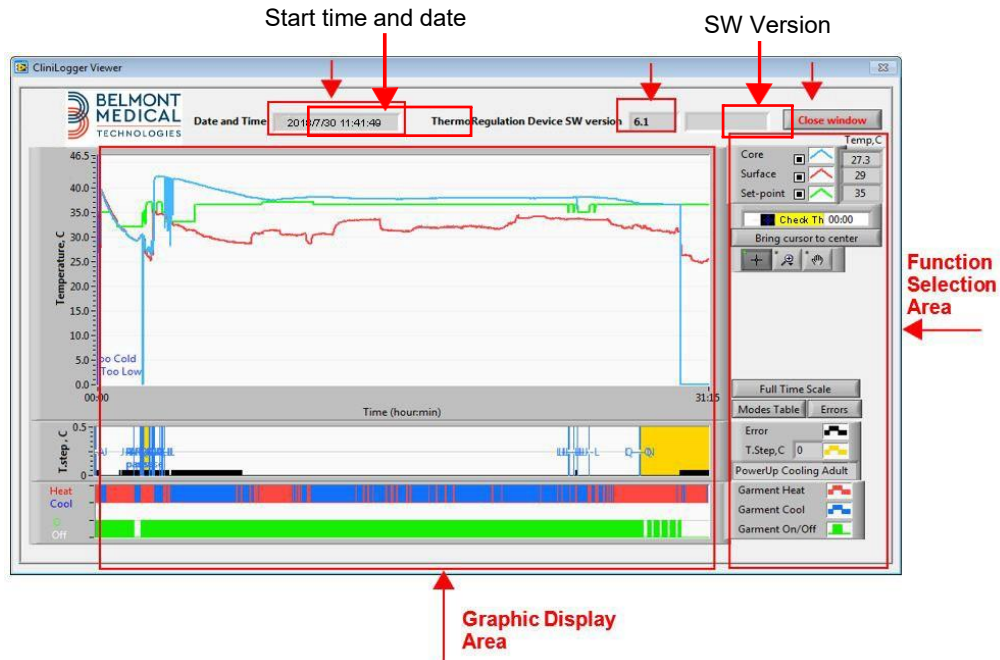

Figure 48: CliniLogger™ Viewing Panel

The CliniLogger™ viewing panel includes the following data:

- Start date and time received from the thermoregulation device (Allon® / CritiCool®)
- Software version of the thermoregulation device
- **Close Window** button
- Function Selection Area: Control keys
- Graphic Display Area with a graphic presentation of the Thermoregulation system variables.

Graphic Display Area

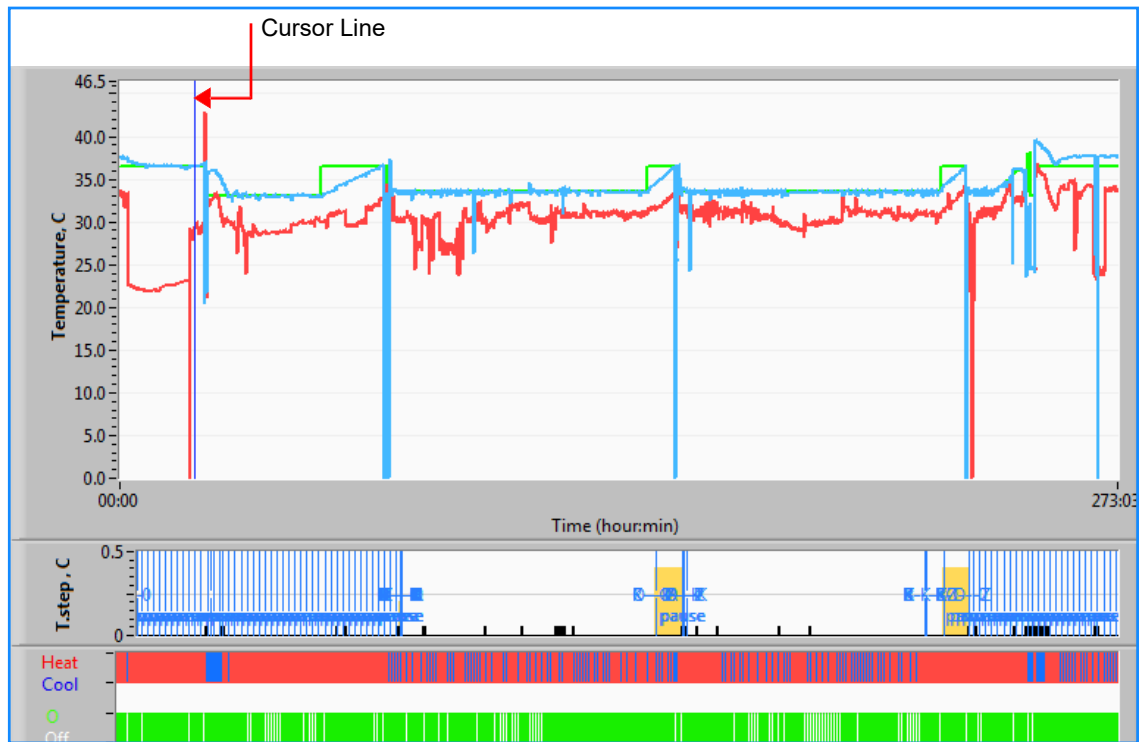

Figure 49: Graphics Display Area

- The Graphic Display area consists of three parts:
 - **Temperatures Graphs:** Set-point, Core and Surface as a function of time
 - **Modes and Error Area:** Thermoregulation modes, Rewarming step and errors as a function of time
 - **Device Functional Status Area:** Heat/Cool and Pump On/Off

Function Selection Area

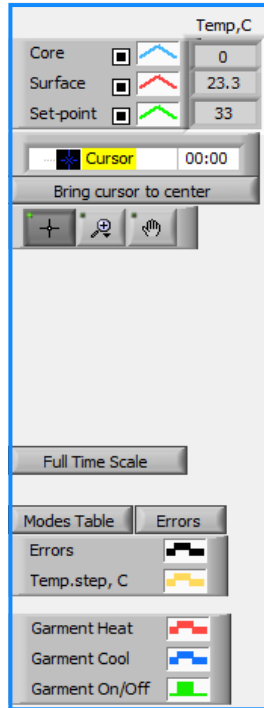

Figure 50: Function Selection Area

The Function Selection area includes the keys that provide the ability to modify the Graphic Display area, such as zooming in and out, moving between time zones and detailing the viewed data.

Temperature Graph Control Buttons:

These buttons define the shape of the curves in the temperature graphs area, the water heat/cool graph and the water flow graph.

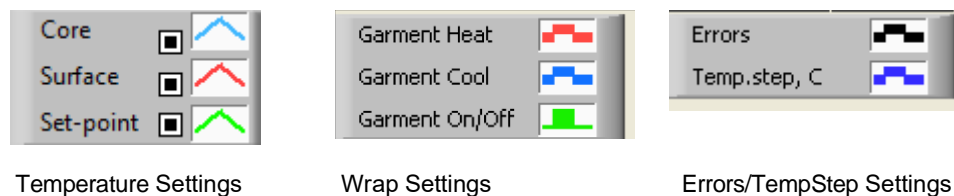

Figure 51: Example Modes and Errors Area

Temperature graph control buttons enable modifying the display of each of the temperature graphs.

Display / Hide Buttons

Use the Temperature Setting toggle buttons to Display / Hide each of the temperature graphs.

Color Buttons

These buttons give the abilities to change the graph features and colors.

NOTE: It is recommended to keep the default settings.

View Manipulation Buttons

A set of three buttons is shown under the temperature buttons:



Hand - Click the Hand  button, using the mouse move the hand cursor to the temperature graph area, and “grab” the curve by pressing the mouse left button and moving the mouse.

Moving the mouse horizontally will move the graphs horizontally - in time, and moving the mouse vertically, will move the graphs vertically - in temperature.

Zoom - Clicking the Zoom button shows 6 modes of zoom use (see Table 14):

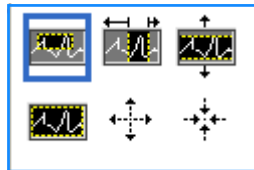

Figure 52: Zoom Toolbar

Table 14: Zoom Tool Buttons







Button	Click to...	How to use...
	Return the graphs to the default (un-zoomed) display	
	Zoom out symmetrically in X and Y directions	Click this zoom tool button. Using the mouse move the cursor to the Temperature graph; the cursor image changes to the button icon. Click the mouse to zoom out. You can click again to zoom out again.

Table 15: Zoom Tool Buttons (con't)

Button	Click to...	How to use...
	Zoom in symmetrically in X and Y directions	Click this zoom tool button. Using the mouse move the cursor to the Temperature graph; the cursor image changes to the button icon. Click the mouse to zoom in. You can click again to zoom in again.
	Create an XY zoom in box.	Click this zoom tool button. Using the mouse move the cursor to the Temperature graph; the cursor image changes to zoom icon. Press the left mouse button and select the box in the graph for zooming in. Once you release the mouse button the image is zoomed in.
	Zoom in, in the X (Time) direction.	Click this zoom tool button, using the mouse move the Zoom tool cursor to the required point of time, click to insert the low limit line, keep the left key pressed and pull horizontally to the end of the interesting time. Once you release the mouse button the image is zoomed in.
	Zoom in, in the Y (Temperature) direction.	Use the mouse move the Zoom tool cursor to the lower temperature limit, click to insert the low limit line, keep the left key pressed and pull vertically. Release the key to view the temperature graphs zoomed in the selected vertical area.

1. To return to full time scale after zoom actions:

1. Click on .

The graph returns to the full time range, without affecting the Temperature scale.

NOTE: To return to the original display click the unzoom button .

Cursor Line

The values of the temperatures at the cursor line location appear in the window adjacent to the curve color window (see Figure 48).

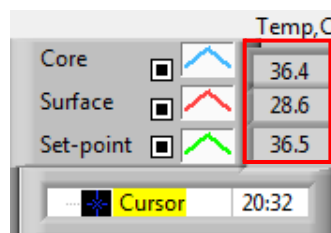

You can change the time of the Cursor Line on the graph (see in Figure 49).



1. To set the time of the cursor:

1. Use the keyboard to set the required time in the **Cursor** textbox. Make sure to select the time as displayed on the graph (and in the HH:MM format).

2. Press ENTER.

The cursor moves to the selected time spot and the Temperatures displayed are the temperatures of the new spot.

2. To move the cursor line, in time (X direction):

1. Click the Cursor  icon.
2. Bring the + to the cursor location, The + will convert to a double line .
3. Use the mouse to move the double line to a new cursor location.

NOTE: The values of the temperature at the cursor location appear in the window adjacent to the curve color window.

3. To bring cursor to the center of the graph:

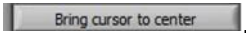
1. Click .

Modes and Error Area

This area provides the following information:

- **System mode** marked by letters (See Table 15) and a vertical line.
- **Rewarming** steps between 0°C and 0.5°C shown in the example in pink (the step was first 0.4°C and then changed to 0.2°C).
- **Error:** Period with no control, in the example due to system pause (yellow markings).



Figure 53: Example of “Modes and Error Area”

Table 15: Mode Codes

Code	Indicates		
A	PowerUp	Cooling	Adult
B	PowerUp	Cooling	Neonate
C	PowerUp	Warming	Adult
D	PowerUp	Warming	Neonate
E	PowerUp	Rewarm	Adult

Table 16: Mode Codes (cont't)

Code	Indicates		
F	PowerUp	Rewarm	Neonate
G	PowerUp	StandBy	
H	PowerUp	Sel.Mode	Adult
I	PowerUp	Sel.Mode	Neonate
J	Cooling	Adult	
K	Cooling	Neonate	
L	Warming	Adult	
M	Warming	Neonate	
N	Rewarming	Adult	
O	Rewarming	Neonate	
P	StandBy		
Q	Select Mode	Adult	
R	Select Mode	Neonate	

Functional Status Area – Heat/Cool and Pump On/ Power Off

The graphs indicate the state of the wrap: **Heat / Cool** modes and the **On/Off of water circulation** in the wrap.

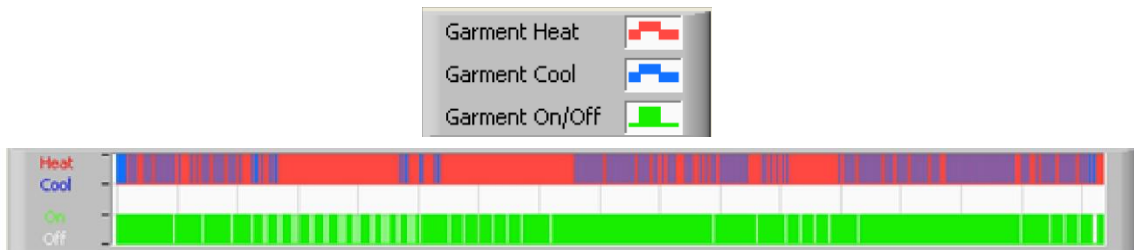

- **Heat/Cool-** When Allon® is cooling the water in the tank- the line is blue. When the device is warming the water in the tank- the line is red.
- **Pump On/Off-** When the pump is pumping water into the Wrap- the line is green. When Allon® is circulating the water internally (i.e. in "Standby mode") the line is white.

Converting to Excel

1. To convert to Excel:

1. On the CliniLogger™ menu panel (see in Figure 44) select **Convert to Excel**; an Excel file opens with two options:

Measurement Table (Sheet 1)

	A	B	C	D	E	F	G	H
1	Date&Time	Record Time	Core	Surface	Set-Point	Mode	Errors	
2	2018/ 6/11 1:50:34	0: 0	33.2	29.7	33.5 K			
3	2018/ 6/11 1:51:34	0: 1	33.3	29.9	33.5 K			
4	2018/ 6/11 1:52:34	0: 2	33.3	30.2	33.5 K			
5	2018/ 6/11 1:53:34	0: 3	33.2	30.3	33.5 K			
6	2018/ 6/11 1:54:34	0: 4	33.3	30.6	33.5 K			
7	2018/ 6/11 1:55:34	0: 5	33.3	30.7	33.5 K			
8	2018/ 6/11 1:56:34	0: 6	33.3	30.8	33.5 K			
9	2018/ 6/11 1:57:34	0: 7	33.4	30.8	33.5 K			
10	2018/ 6/11 1:58:34	0: 8	33.4	33.8	33.5 K			
11	2018/ 6/11 1:59:34	0: 9	33.4	34.2	33.5 K			
12	2018/ 6/11 2: 0:34	0:10	33.4	34.5	33.5 K			
13	2018/ 6/11 2: 1:34	0:11	33.4	28.5	33.5 K			
14	2018/ 6/11 2: 2:34	0:12	33.5	27	33.5 K			
15	2018/ 6/11 2: 3:34	0:13	33.5	27	33.5 K			
16	2018/ 6/11 2: 4:34	0:14	33.5	27.7	33.5 K			
17	2018/ 6/11 2: 5:34	0:15	33.5	27.1	33.5 K			
18	2018/ 6/11 2: 6:34	0:16	33.5	27.6	33.5 K			
19	2018/ 6/11 2: 7:34	0:17	33.6	30.2	33.5 K			

Graphic Chart

A second page in the Excel file shows a graphic description of the Excel table with the Y axis showing the temperatures, and the X axis the Excel table lines.

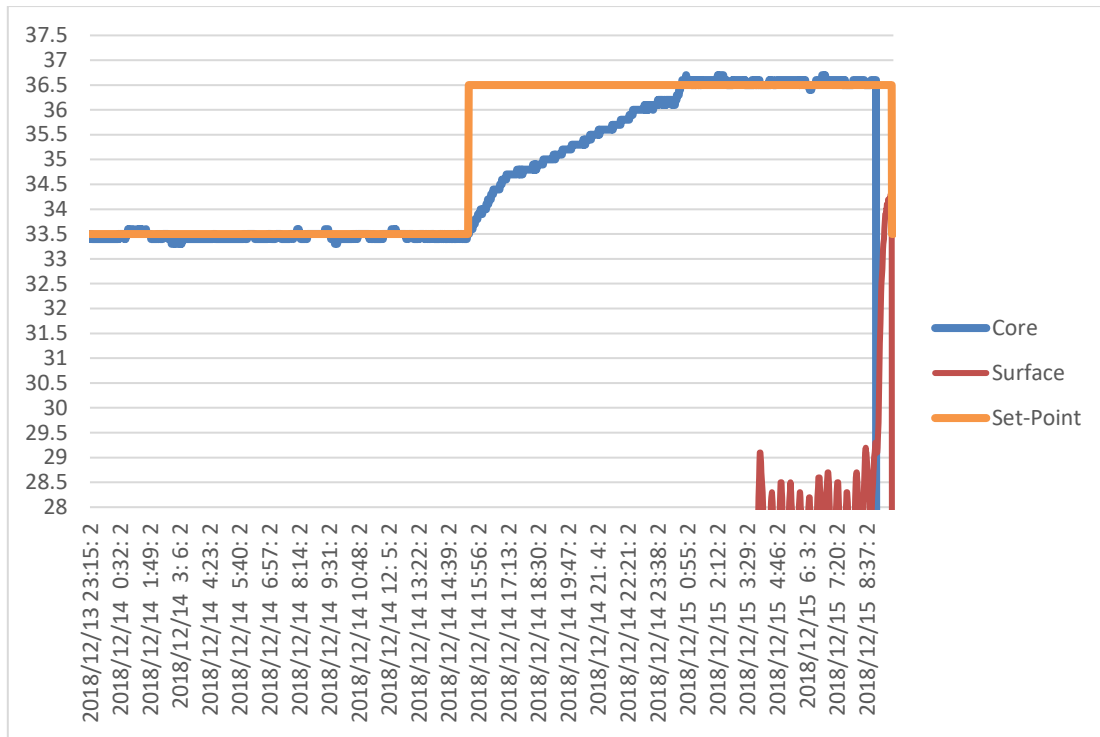

Figure 54: Selection of Graph Chart

Ending a Viewing Session

1. To end a session:

- a. Click **Quit** on the Main Menu to exit the Viewing Session.

Technician Software

NOTE: The Technician Software can only be run after performing a full installation of the User Software. See 'Installing the Software' section for more information on this process.

Installation Procedure:

- Copy the folder "900-00350 CliniLogger Viewer Software_Tech v1.6.3" from the CD to a location on the desired PC.
- Run the CliniLogger tech.exe application.

Appendix A: Customer Service

Belmont Medical Technologies Customer Service Representative

WARNING!!! The following details are necessary to contact your Belmont Medical Technologies representative. Keep this form with the User's Manual for easy access for scheduling annual periodic maintenance and/or for servicing needs.

Representative Name:	
Company Name:	
Address:	
Telephone No:	
Fax:	
E-mail:	

Passcode for Settings Screen:

Appendix B: EMI / EMC Information

WARNING!

Medical Electrical Equipment needs special precautions regarding EMC and needs to be installed and put into service according to the Electromagnetic Compatibility [EMC] information provided in the accompanying documents.

WARNING!

Portable RF communications equipment should be used no closer than 30 cm to any part of the device, otherwise degradation of the performance of this equipment could result

NOTE: The EMC tables and other guidelines that are included in the Operators Manual provide information to the customer or user that is essential in determining the suitability of the Equipment or System for the Electromagnetic Environment of use, and in managing the Electromagnetic Environment of use to permit the Equipment or System to perform its intended use without disturbing other Equipment and Systems or non-medical electrical equipment.

The essential performance features of Allon are the accuracy of the temperature measurement system, the water temperature control, alarms if core temperature is unexpected, and halt conditions in case that any of the elements of the control mechanism fail.

Table 16 Guidance and Manufacturer's Declaration - Emissions

Table 16 Guidance and Manufacturer's Declaration - Emissions		
<p>Allon[®] is intended for use in the electromagnetic environment specified below. The customer or user of Allon[®] should assure that it is used in such an environment.</p>		
Emissions Test	Compliance	Electromagnetic Enforcement – guidance
RF Emissions CISPR 11	Group 1, Class A	The device should not be stacked with other equipment. Use of accessories and cables other than those specified by Belmont could result in increased electromagnetic emissions or decreased electromagnetic immunity of this equipment and result in improper operation.
Harmonics IEC 61000-3-2	Class A	Complies
Flicker IEC 61000-3-3	Complies	Complies

Table 17 Guidance and Manufacturer's Declaration - Immunity

Allon® is intended for use in the electromagnetic environment specified below.
The customer or user of **Allon®** should assure that it is used in such an environment.

Immunity Test	IEC 60601 Passed Parameters
IEC 61000-4-2 Electrostatic Discharge (ESD)	±8kV contact ±15kV air
IEC 61000-4-3 Radiated RF	3 V/m 80MHz-2.7GHz 80% AM @ 1kHz
IEC 61000-4-3 Proximity field Immunity	385 MHz at 27 V/m, 18 Hz Pulse Modulation 450 MHz at 28 V/m, 1 kHz Frequency Modulation ± 5 kHz Dev 810 MHz, 870 MHz, and 930 MHz at 28 V/m, 18 Hz Pulse Modulation 710 MHz, 745 MHz, and 780 MHz at 9 V/m, 217 Hz Pulse Modulation 1720 MHz, 1845 MHz, 1970 MHz, and 2450 MHz at 28 V/m, 217 Hz Pulse Modulation 5240 MHz, 5500 MHz, and 5785 MHz at 9 V/m, 217 Hz Pulse Modulation
IEC 61000-4-4 Electrical Fast Transient/burst	±2kV on AC Mains 100kHz Repetition frequency
IEC 61000-4-5 Surge	±1kV Line-to-line ±2kV Line-to-earth
IEC 61000-4-6 Conducted RF	3 Vrms from 150 kHz to 80 MHz 6Vrms in ISM bands between 0.15 MHz and 80 MHz 80% AM @ 1 kHz
IEC 61000-4-8 Power Frequency 50/60Hz Magnetic Field	30A/m
IEC 61000-4-11 Voltage dips, short interruptions, and voltage variations on power supply input lines	100% Dip for 0.5 Cycle @ 0°, 45°, 90°, 135°, 180°, 225°, 270°, and 315° 100% Dip for 1 Cycle 30% Dip for 25 Cycles 100% Dip for 5 Seconds

Appendix C: Waste Electrical & Electronic Equipment (WEEE)

The crossed-out wheel bin symbol on the product, literature, or packaging reminds you that all electrical and electronic products, batteries, and accumulators must be taken to separate collection at the end of their working life. This requirement applies to the European Union and other locations where separate collection systems are available. To prevent possible harm to the environment or human health from uncontrolled waste disposal, please do not dispose of these products as unsorted municipal waste, but instead, hand in at an official collection point for recycling.